



INSTRUCTIONS

-J02028

REV. 2010-09-07

REMOTE CONTROL GARAGE DOOR OPENER KITS

GENERAL

Kit Numbers

91558-01A (Transmitter/Receiver Kit), 91561-01 (Transmitter Kit), 91562-01 (Receiver Kit)

Models

For model fitment information, see the P&A retail catalog or the Parts and Accessories section of www.harley-davidson.com (English only).

Additional Parts Required

2011 and later Softail models will require separate purchase of an Electrical Connection Harness (Part No. 72673-11).

Tools and Supplies Required

Electrical Contact Lube (Part No. 99861-02) or equivalent is required after battery cable disconnection. This item is available from a Harley-Davidson dealer.

⚠ WARNING

The rider's safety depends upon the correct installation of this kit. Use the appropriate service manual procedures. If the procedure is not within your capabilities or you do not have the correct tools, have a Harley-Davidson dealer perform the installation. Improper installation of this kit could result in death or serious injury. (00333a)

NOTE

This instruction sheet refers to service manual information. A service manual for this year/model motorcycle is required for this installation and is available from a Harley-Davidson dealer.

Electrical Overload

NOTICE

It is possible to overload your vehicle's charging system by adding too many electrical accessories. If the combined electrical accessories operating at any one time consume more electrical current than the vehicle's charging system can produce, the electrical consumption can discharge the battery and cause damage to the vehicle's electrical system. See an authorized Harley-Davidson dealer for advice about the amount of current consumed by additional electrical accessories or for necessary wiring changes. (00211c)

⚠ WARNING

When installing any electrical accessory, be certain not to exceed the maximum amperage rating of the fuse or circuit breaker protecting the affected circuit being modified. Exceeding the maximum amperage can lead to electrical failures, which could result in death or serious injury. (00310a)

The Remote Control Transmitter in kits 91558-01A and 91561-01 requires up to **0.5 Amps** additional current from the electrical system.

Kit Contents

See Figure 27, Table 1, Table 2 and Table 3.

FCC NOTICES

NOTE

Changes or modifications to this unit not expressly approved by the manufacturer could void the user's authority to operate the equipment.

This equipment has been tested and found to comply with the limits for Class B digital devices pursuant to Part 15, Subpart B of the FCC Rules. These limits are designed to provide reasonable protection against harmful interference in a residential environment. This equipment generates, uses, and can radiate radio-frequency energy, and if not installed and used in accordance with the instruction manual, may cause harmful interference to radio communications. However, there is no guarantee that interference will not occur in a particular installation.

If this equipment does cause harmful interference to radio or television reception, which can be determined by turning the equipment off and on, the user is encouraged to try to correct the interference by one or more of the following measures:

- Re-orient or relocate the receiving antenna.
- Increase the distance between the equipment and the receiver.
- Connect the equipment to an outlet on a circuit different from that to which the receiver is connected.
- Consult the dealer or an experienced radio/TV technician for help.

RECEIVER INSTALLATION

Kits 91558-01A and 91562-01 only

1. Unplug the power cord from the garage door drive unit to prevent door activation during installation.
2. Select an **unswitched** 110V power outlet in the garage located either highest in the garage, closest to the front of the garage, or both. Plug the Harley-Davidson remote control garage door opener receiver (14) into this outlet.

NOTE

For some brands of garage door opener systems, it may be necessary to plug in the Harley-Davidson receiver at a location some distance from the door opener. With those systems, if the Harley-Davidson receiver is plugged in too close to the original opener receiver, the effective transmission range may be significantly reduced on both systems.

3. Find the two garage door activation switch terminals at one of the following locations:
 - The existing wall-mounted, hard-wired garage door opener button.
 - The garage door drive unit to which the garage door opener button is connected.
4. See Figure 27. Fasten the stripped end of the Harley-Davidson garage door opener receiver cable assembly (15) to the door opener terminals that activate the door opener drive unit. Refer to the door opener manufacturer's documentation for terminal locations and connections.

NOTE

Do not remove the wires originally connected to the door opener button or drive unit terminals.

5. Assemble and install the garage door opener button or door opener drive unit in the original location.
6. Route the Harley-Davidson garage door opener receiver cable assembly connected in Step 4 to the power outlet selected in Step 2.
7. See Figure 1. Plug the connector on the Harley-Davidson garage door opener receiver cable assembly into the back of the Harley-Davidson garage door opener receiver in the location shown.
8. Plug the garage door opener receiver into the selected power outlet. Plug the power cord from the garage door drive unit into the power outlet.

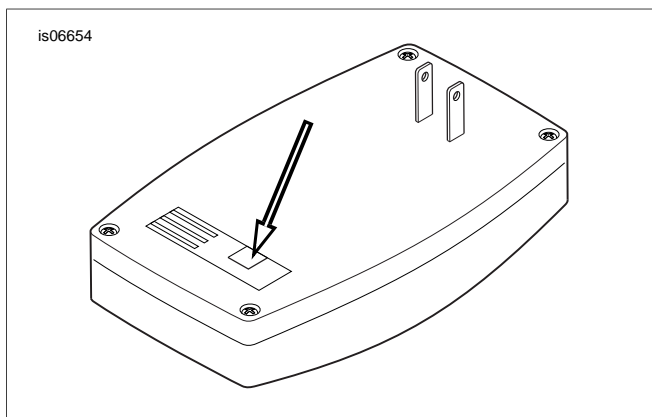

Figure 1. Garage Door Opener Receiver, Back View

9. Press the wall-mounted garage door opener button to test the button operation.

VEHICLE PREPARATION

NOTE

For vehicles equipped with security siren:

- Verify that the Hands-Free Fob is present.
- Turn the ignition key switch to IGNITION.

For V-Rod models only:

Remove the air box aluminum cover per service manual instructions.

For EFI models EXCEPT V-Rod:

WARNING

To prevent spray of fuel, purge system of high-pressure fuel before supply line is disconnected. Gasoline is extremely flammable and highly explosive, which could result in death or serious injury. (00275a)

Follow service manual instructions to purge the fuel supply of high pressure gasoline and remove the fuel supply line.

For ALL vehicles with main fuse:

WARNING

To prevent accidental vehicle start-up, which could cause death or serious injury, remove main fuse before proceeding. (00251b)

1. Refer to the service manual and follow the instructions to remove the main fuse.

All models except V-Rod: Remove and retain the seat and all mounting hardware.

For vehicles with main circuit breaker:

WARNING

To prevent accidental vehicle start-up, which could cause death or serious injury, disconnect negative (-) battery cable before proceeding. (00048a)

1. Refer to the service manual and follow the instructions to remove the seat and disconnect the negative (black) battery cable from the negative (-) battery terminal. Retain all seat mounting hardware.

For Carbureted Models:

WARNING

Gasoline can drain from the carburetor fuel line when disconnected from fuel valve fitting. Gasoline is extremely flammable and highly explosive, which could result in death or serious injury. Wipe up spilled fuel immediately and dispose of rags in a suitable manner. (00256a)

2. Turn the fuel supply valve to OFF. Remove the fuel line from the valve.

For Dyna, Softail and Sportster models:

WARNING

When servicing the fuel system, do not smoke or allow open flame or sparks in the vicinity. Gasoline is extremely flammable and highly explosive, which could result in death or serious injury. (00330a)

3. The fuel tank must be removed or slightly raised to access wiring underneath. See the correct section (Carbureted or EFI Engine) of the service manual for fuel tank bolt removal instructions.

If the fuel tank must be removed, follow the instructions in the service manual to remove the instrument console (if equipped) from the fuel tank before removing the tank.

TRANSMITTER INSTALLATION

Kits 91558-01A and 91561-01 only

NOTE

Transmitter effective range may vary between motorcycle models. For best garage door opener **range**, position the transmitter on the motorcycle as far as possible from large metal surfaces.

For best garage door opener **performance**, keep the transmitter and wires as far from vehicle heat sources as possible

Do not cover the view of the circuitry on the transmitter when fastening the foam tape retainer pad to the transmitter or mounting the transmitter to the vehicle. A red LED on the circuitry side must remain visible for programming the receiver-transmitter. For best adhesion, use isopropyl alcohol to clean the surfaces to which the tape pad will mount.

1. See Figure 27. Remove the liner from the adhesive backing on one side of the tape pad (3). Carefully position the pad to the plastic casing of the transmitter (1), and press firmly into place.
2. Find specific model instructions in the sections that follow.

Dyna Models

1. Remove the fuel tank mounting bolts. See the correct section (Carbureted or EFI Engine) of the service manual.
2. See Figure 2. Use cable straps to fasten the transmitter to the Dyna wire harness (3), located under the seat and near the battery compartment. Route the transmitter wires forward along the right side of the frame.

Proceed to the **Harness Connection** section.

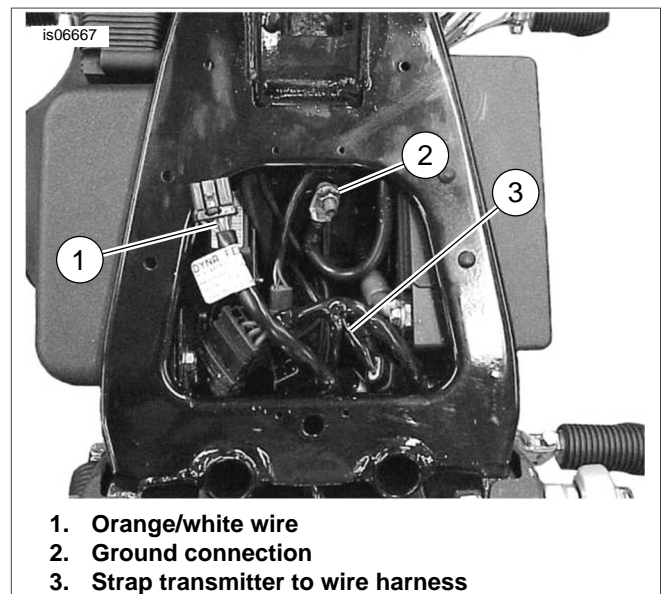

Figure 2. Transmitter Mounting (Dyna)

1999 and Earlier Softails

1. Remove the fuel tank mounting bolts. See the correct section (Carbureted or EFI Engine) of the service manual.
2. See Figure 3. Remove the ground screw (1), located on the top of the frame, under the seat near the fuel tank.
3. See Figure 27. Use cable straps (8) from the kit to fasten **only the transmitter case and the short section of conduit** to the motorcycle wires leading forward toward the headlamp.

Proceed to the **Harness Connection** section.

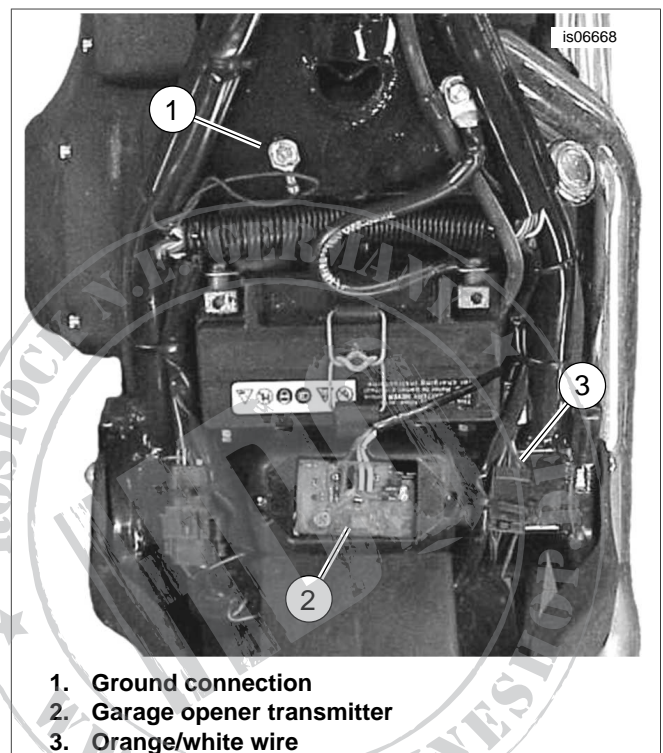

Figure 3. Transmitter Mounting (1999 and Earlier Softails)

2000 and Later Softails, Except Deuce (FXSTD)

1. Remove the fuel tank mounting bolts. See the correct section (Carbureted or EFI Engine) of the service manual.
2. Remove the rear splash guard (inner fender) per service manual instructions.
3. See Figure 4. Use cable straps from the kit to fasten the transmitter (3) to the wire harness located between the frame, rear fork (2), and rear tire (1).
4. See Figure 5. Route the transmitter wires (2) up to the battery compartment (4) and along the right side of the frame.

Proceed to the **Harness Connection** section.

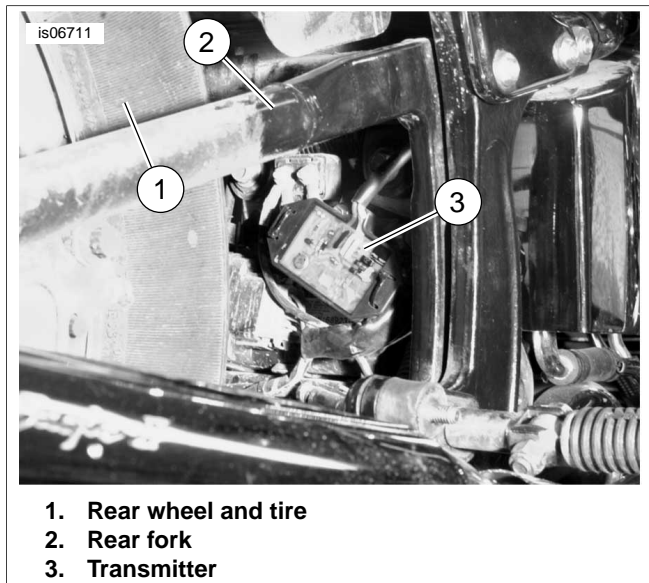

Figure 4. Transmitter Mounting, 2000 and Later Softails, Except Deuce (FLSTC Shown)

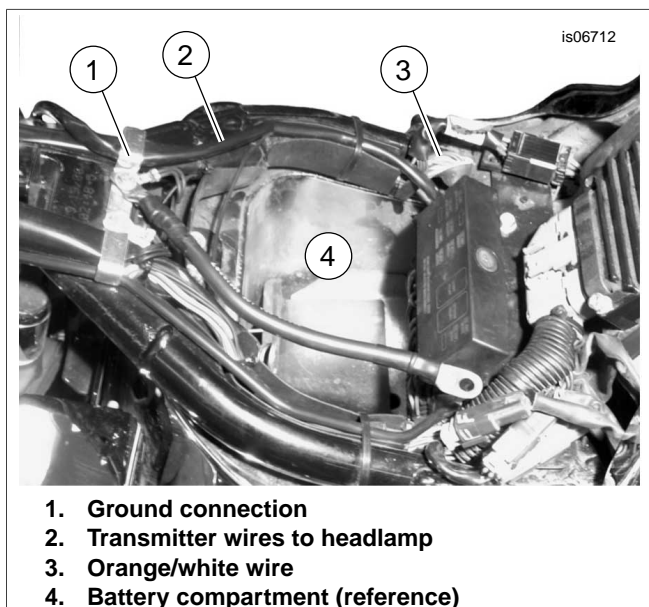

Figure 5. Power and Ground Connections, 2000 and Later Softails (FLSTC Shown)

2000 and Later Softail Deuce (FXSTD)

1. Remove the fuel tank mounting bolts. See the correct section (Carbureted or EFI Engine) of the service manual.
2. Remove the liner from the adhesive backing of the tape pad on the transmitter.
3. See Figure 6. Mount the transmitter to the surface below the ECM/ignition module. Route the transmitter wires forward along the right side of the frame.

Proceed to the **Harness Connection** section.

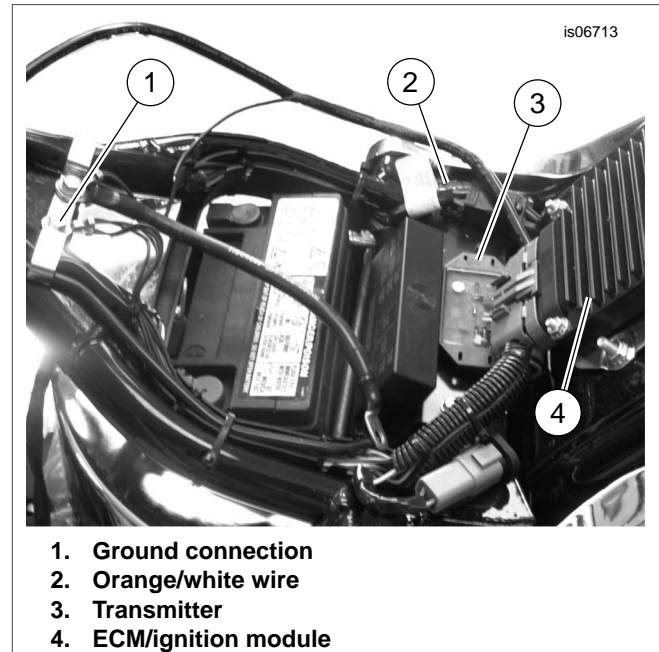
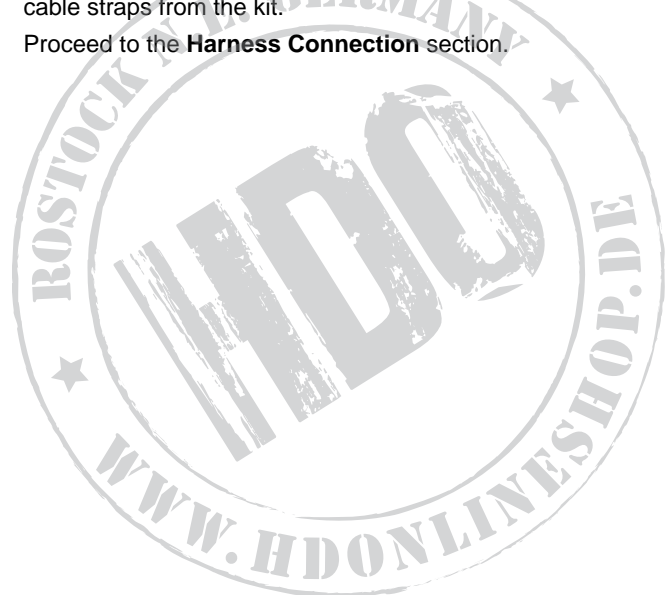

Figure 6. Transmitter Mounting, 2000 and Later Deuce

1994-2003 Sportster Models

1. Remove the fuel tank. See the correct section (Carbureted or EFI Engine) of the service manual.
2. See Figure 7. Position the transmitter (1) to the main wire harness in the area under the seat, as far as possible from the oil tank, and fasten the transmitter to the harness using cable straps from the kit.

Proceed to the **Harness Connection** section.



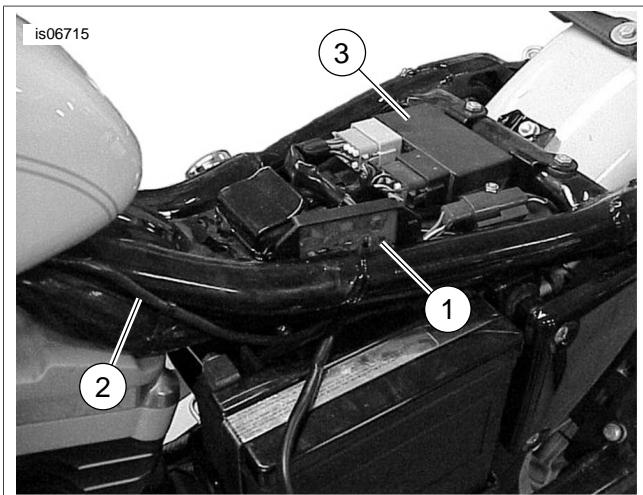

1. Transmitter mounting location
2. Wires to headlamp
3. Ignition module

Figure 7. Transmitter Mounting and Wire Routing, (2003 or Earlier Sportster Models)

2004 and Later Sportster Models

1. Remove the fuel tank. See the correct section (Carbureted or EFI Engine) of the service manual.
2. Remove the electrical side cover, located on the left side of the motorcycle near the battery.
3. See Figure 27. Position the transmitter (1) behind the electrical side cover. Orient the transmitter so the printed circuit side faces away from the battery, and fasten the transmitter to the wire harness next to the main fuse holder using cable straps (8) from the kit.

Proceed to the **Harness Connection** section.

FLHR Touring Models

1. Remove the headlamp from the nacelle per the instructions in the service manual.
2. Remove the liner from the adhesive backing of the tape pad on the transmitter.
3. See Figure 8. Mount the transmitter to the right side of the frame near the fork tube.

Proceed to the **Harness Connection** section.

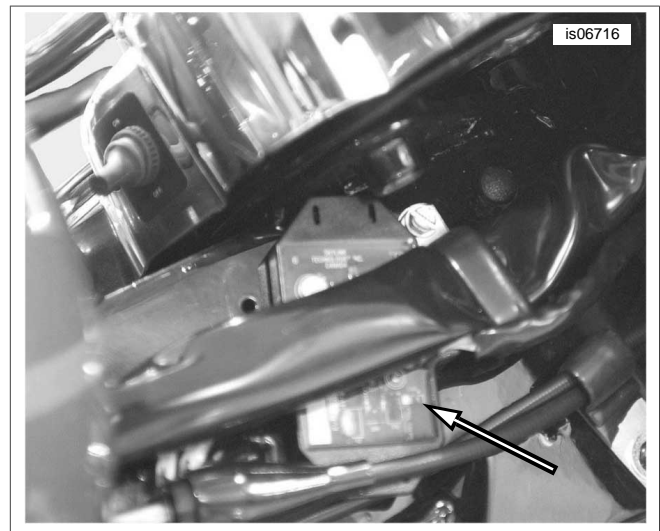
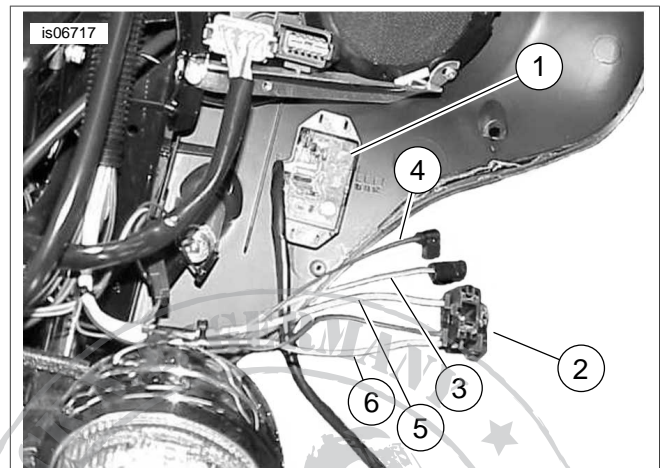

Figure 8. Transmitter Mounting Near Fork Tube (FLHR)

FLHT, FLHX and FLTR Touring Models; Trike Models

1. Remove the outer fairing per the instructions in the service manual.
2. Remove the liner from the adhesive backing of the tape pad on the transmitter.
3. See Figure 9 (FLHT, FLHX models) or Figure 10 (FLTR models). Mount the transmitter to the upper inside of the fairing.

Proceed to the **Harness Connection** section.



1. Mount transmitter to fairing
2. Headlamp connector
3. Orange/white wire
4. Black wire
5. White wire
6. Yellow wire

Figure 9. Wires for Transmitter Connections (FLHT/X)

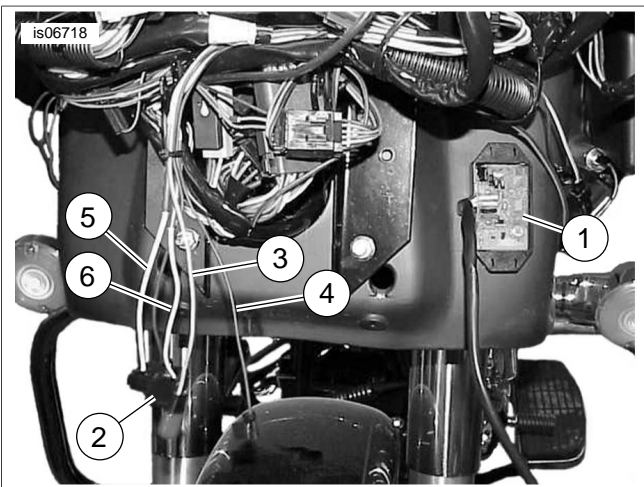

1. Mount transmitter to fairing
2. Headlamp connector
3. Orange/white wire
4. Black wire
5. White wire
6. Yellow wire

Figure 10. Wires for Transmitter Connections (FLTR)

2002-2003 V-Rod Models

1. See Figure 11. Remove the screw (3) fastening the front left louvered cover (1) to the motorcycle. Lift the louvered cover off the tabs (2) to remove the cover.
2. See Figure 12. Use cable ties to fasten the transmitter (1) to the motorcycle wire casing (2) as shown.

Proceed to the **Harness Connection** section.

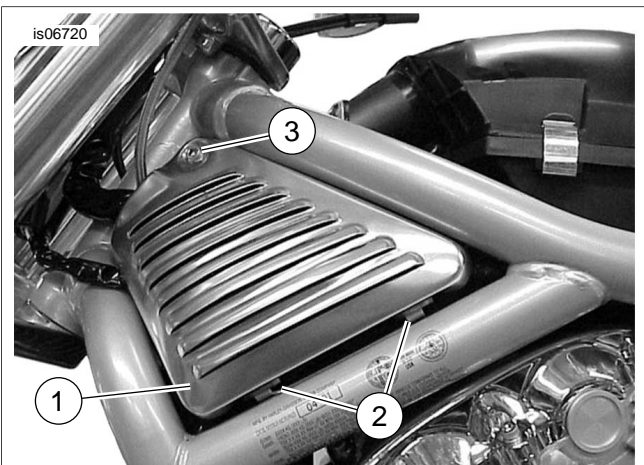

1. Louvered cover
2. Tab (2)
3. Screw

Figure 11. Left-Side Louvered Cover (2002-2003 V-Rod Shown)

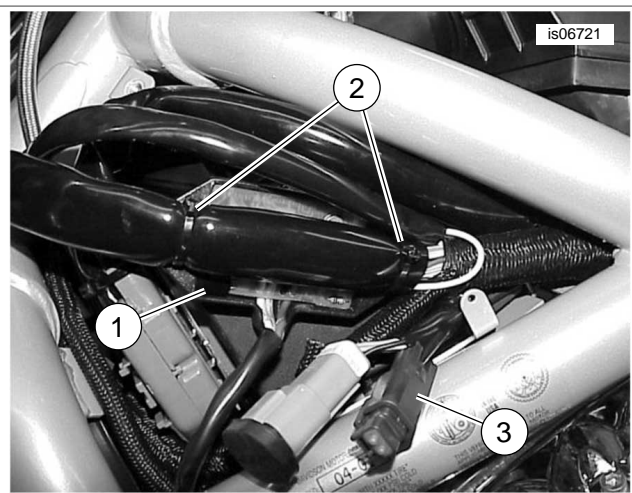

1. Transmitter
2. Tie transmitter cable to wire casing
3. Connector with black (ground) and orange wires

Figure 12. Transmitter Mounting (2002-2003 V-Rod Only)

2007 and Later V-Rod Models

1. See Figure 11. Remove the screw (3) fastening the front left louvered cover (1) to the motorcycle. Lift the louvered cover off the tabs (2) to remove the cover.
2. See Figure 13. Remove the air box cover. Rotate the transmitter (1) so the exposed circuit side faces up. Tuck the transmitter under the fuse block wire harnesses. Use two cable straps from the kit through the flanges of the transmitter to secure the transmitter to the fuse block harnesses.

Proceed to the **Harness Connection** section.

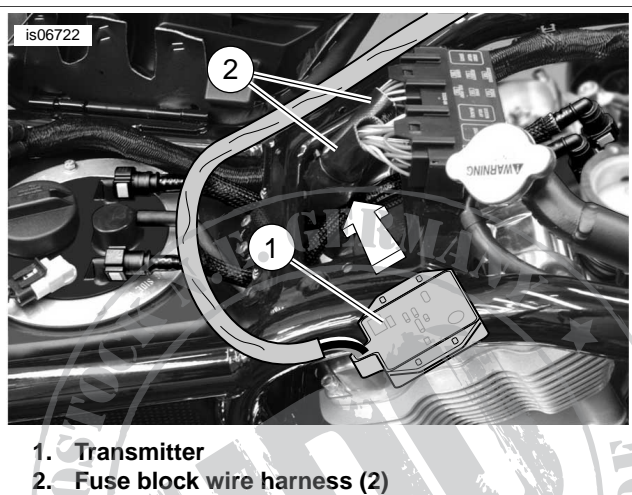

1. Transmitter
2. Fuse block wire harness (2)

Figure 13. Transmitter Mounting (2004 and Later V-Rod)

HARNES CONNECTION

General

Splicing of wire leads is necessary in the installation of the garage door opener to the vehicle. Find the instructions for a specific model in the sections that follow, and refer to the service manual appendix for proper wire splicing procedures.

⚠ WARNING

Be sure to follow manufacturer's instructions when using the UltraTorch UT-100 or any other radiant heating device. Failure to follow manufacturer's instructions can cause a fire, which could result in death or serious injury. (00335a)

- Avoid directing heat toward any fuel system component. Extreme heat can cause fuel ignition/explosion resulting in death or serious injury.
- Avoid directing heat toward any electrical system component other than the connectors on which heat shrink work is being performed.
- Always keep hands away from tool tip area and heat shrink attachment.

For 2011 and later Softail models: Proceed to the following section.

For Touring and Trike models: Proceed to **that** section.

For ALL OTHER models: Proceed to **Black Lead Connection** for the specific model.

2011 and Later Softail Models

NOTES

Requires separate purchase of Electrical Connection Harness (H-D Part No. 72673-11).

Electrical connectors are identified in the service manual by the number and letter shown here within brackets.

1. Locate the Digital Technician connector [91A] (a gray six-way Deutsch pin connector with a rubber boot) under the seat. Place the Electrical Connection Harness at connector [91A], but DO NOT connect at this time.
2. Route the garage door opener wires over to the Electrical Connection Harness. Remove the orange/white wire from the conduit. Cut the orange/white and black wires to a suitable length to easily reach the sealed splice connectors on the Electrical Connection Harness. DO NOT cut the yellow or white wires.
3. Splice the black garage door opener wire to the **black** wires in the Electrical Connection Harness.
4. Splice the orange/white garage door opener wire to the **red/yellow** wires in the Electrical Connection Harness.
5. Use a heat gun or suitable radiant-heating device to shrink the connector to the wires.
6. Use the heat gun or heating device to seal the open end of the sealed splice connector on the **red/blue** wires in the Electrical Connection Harness.
7. Pull the rubber boot out from the gray Digital Technician pin connector [91A]. Cut the boot off of the wires.
8. Connect the socket housing of the Electrical Connection Harness to connector [91A].

9. Insert the rubber boot into the open pin connector of the Electrical Connection Harness.
10. Loosen or remove the four screws holding the ECM to the mounting bracket. Route the Electrical Connection Harness under the ECM connector. Tighten the four screws to 45-55 **in-lbs** (5.1-6.2 Nm).
11. Proceed to the **Yellow and White Lead Connections** section for the specific model.

Touring and Trike Models

1. Cut the yellow, white and orange/white **transmitter** wires to about the same length as the transmitter black ground wire. Cut to allow enough wire to easily strip and splice the wires.

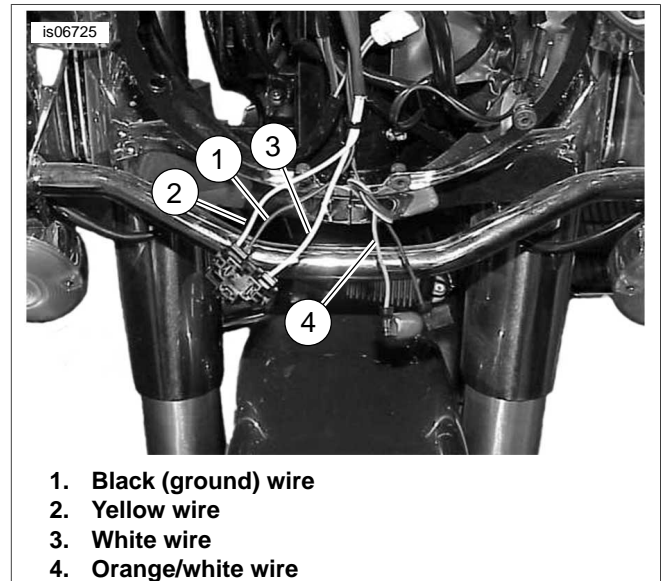

1. **Black (ground) wire**
2. **Yellow wire**
3. **White wire**
4. **Orange/white wire**

Figure 14. Wires for Transmitter Connections (FLHR)

2. **FLHR Touring Models:** See Figure 14. Cut the yellow (2), black (1) and white (3) headlamp wires **inside the nacelle**, staggering the lengths a bit to avoid all three splices being together.
FLHT and FLHX Touring and Trike Models: See Figure 9. Cut the yellow (6), black (4) and white (5) headlamp wires **inside the fairing**, staggering the lengths a bit to avoid all three splices being together.
FLTR Touring Models: See Figure 10. Cut the yellow (6), black (4) and white (5) headlamp wires **inside the fairing**, staggering the lengths a bit to avoid all three splices being together.
ALL Touring/Trike Models: Slide the woven wire conduit from the kit (see Figure 27, Item 9) over all three headlamp wires.
3. See Figure 15, the 2 into 1 splice configuration. Use a **red** sealed splice connector (Figure 27, Item 4) from the kit to splice the black garage door opener transmitter wire to the **black** wires from the headlamp. Trim back the transmitter wire harness casing as needed to assist splicing.

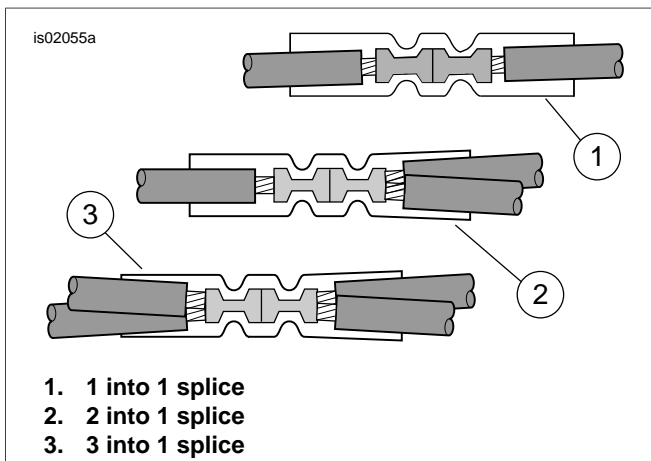

Figure 15. Splice Configurations

NOTE

Electrical connectors are identified in the service manual by the number and letter shown here within brackets.

4. Use the remaining red sealed splice connector to splice the orange/white transmitter wire to the orange/white wire on the unused position lamp connector [29B]:
 - **For FLHR Touring Models**, tied to the main harness inside the nacelle.
 - **For ALL OTHER Touring/Trike Models**, tied to the interconnect harness near the headlamp.
5. See Figure 27. Use a **blue** sealed splice connector (5) from the kit to splice the white transmitter wire to the white headlamp wires. Use the remaining blue sealed splice connector to splice the yellow transmitter wire to the yellow headlamp wires.
6. Slide the wire conduit over the splice area of the three headlamp wires.
7. Proceed to the **Receiver and Transmitter Programming** section to program the garage door opener controls.

BLACK LEAD CONNECTION TO GROUND

Dyna Models

1. Remove the nut from the ground stud, located on the top of the frame, under the seat near the fuel tank.
2. See Figure 27. Select the correct ring terminal (6 or 7) from the kit to fit the ground stud.
3. See Figure 2. Cut the black ground wire (2) on the garage door opener wire harness to easily reach the ground location, and crimp the ring terminal to the end of the wire per the Packard crimping tool instructions in the service manual appendix.
4. Install the ring terminal to the ground connection, and secure per the torque specification in the service manual.
5. Proceed to the **Orange/White Lead Connection** section for the specific model.

2010 and Earlier Softail Models

1. Remove the ground screw, located on the top of the frame, under the seat near the fuel tank.

2. See Figure 27. Select the correct ring terminal (6 or 7) from the kit to fit the ground screw.
3. Cut the black wire on the garage door opener wire harness to easily reach the ground location, and crimp the ring terminal to the end of the wire per the Packard crimping tool instructions in the service manual appendix.
4. See Figure 5. Install the ring terminal onto the ground screw threads. Fasten the ground screw to the frame and secure per the torque specification in the service manual.
5. Proceed to the **Orange/White Lead Connection** section for the specific model.

Sportster Models

1. Remove the electrical side cover, located on the left side of the motorcycle near the battery.
2. Route the garage door opener wire harness through the top of the frame under the seat to the circuit breaker located on the inside of the electrical side cover.
3. See Figure 16. Remove the ground screw (1), located:
 - Under the seat on some 1996-2003 models, or
 - Near the swingarm on 1995 or earlier models, and 1996-2003 models without a screw under the seat.
 - On the engine near the starter on 2004 and later models.
4. See Figure 27. Select the correct ring terminal (6 or 7) from the kit to fit the ground screw.
5. Cut the black wire on the garage door opener wire harness to easily reach the ground location, and crimp the ring terminal to the end of the wire per the Packard crimping tool instructions in the service manual appendix.
6. Install the ring terminal onto the ground screw threads. Fasten the ground screw at the original location, and secure per the torque specification in the service manual.
7. Proceed to the **Orange/White Lead Connection** section for the specific model.



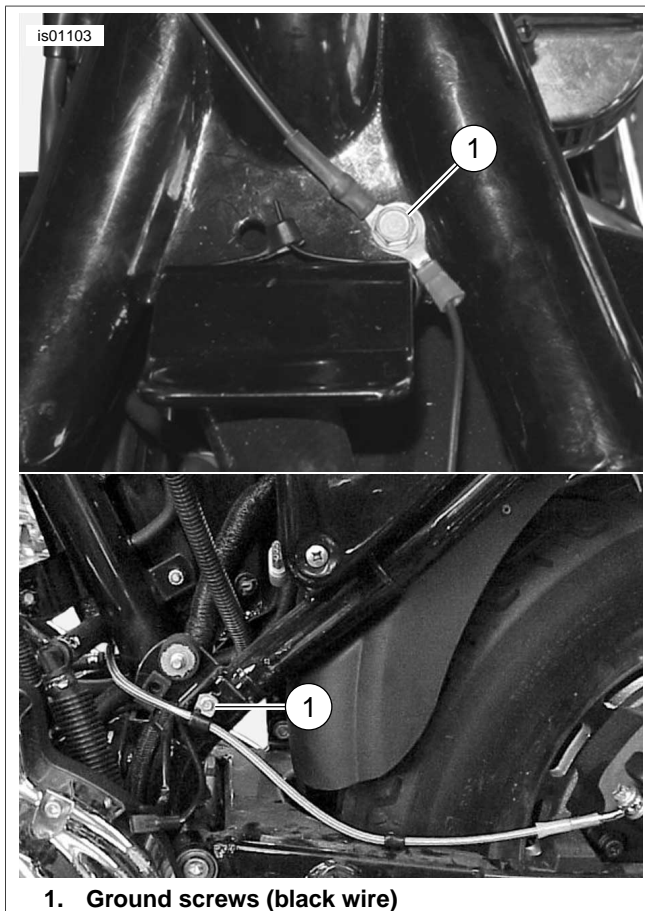

1. Ground screws (black wire)

Figure 16. Ground Connections (Sportster Models)

2002-2003 V-Rod Models

1. Cut the black transmitter ground wire to within easy reach of one of the ground screws located on the engine cam covers. Remove the ground screw.
2. See Figure 27. Select the 1/4 in. (6.4 mm) ring terminal (7) from the kit. Crimp the ring terminal onto the black transmitter wire per the Packard crimping tool instructions in the service manual appendix.
3. Fasten the ring terminal to the engine with the ground screw, and secure per the torque specification in the service manual.
4. Proceed to the **Orange/White Lead Connection** section for the specific model.

2004 and Later V-Rod Models

1. See Figure 15, the 2 into 1 splice configuration. Use a **red** sealed splice connector (Figure 27, Item 4) from the kit to splice the black wire (13) from the kit to the black transmitter ground wire according to the instructions in the service manual appendix.
Slip the conduit (10) from the kit over the spliced ground wire.
2. Route the ground wire and conduit along the motorcycle frame to the left of the air box, next to the main harness to a location under the left-side louvered cover.
3. Cut the black transmitter ground wire and conduit to within easy reach of one of the ground studs located on each end of the battery ground cable.

4. Select the 1/4 in. (6.4 mm) ring terminal (7) from the kit. Crimp the ring terminal onto the black transmitter wire per the Packard crimping tool instructions in the service manual appendix.
5. Fasten the black wire ring terminal to the negative terminal mounting post on the battery. Tighten the terminal fastener to 60-96 **in-lbs** (7-10 Nm).
6. Proceed to the **Orange/White Lead Connection** section for the specific model.

ORANGE/WHITE LEAD CONNECTION TO SWITCHED POWER SOURCE

Use the service manual wiring diagrams for a specific model and year vehicle to locate a power source that is fed through the ignition switch.

2003 and Earlier Dyna Models

The garage door opener **switched** power source is an orange/white (O/W) main harness power lead under the seat or inside the side cover.

1. Remove the electrical side cover, located on the left side of the motorcycle near the battery.
2. See Figure 2. Carefully slice open an area of the main harness wrap under the seat or inside the side cover at an accessible point, and cut an orange/white main harness power lead.
3. Pull **only** the orange/white wire out of the longer piece of conduit on the garage door opener wire harness. Cut the excess length from the orange/white wire to within easy reach of the cut orange/white wires on the main vehicle harness.
4. See Figure 15, the 2 into 1 splice configuration. Use a **red** sealed splice connector (Figure 27, Item 4) from the kit to splice the garage door opener wire harness power lead to the main harness orange/white wires per the instructions in the service manual appendix.
5. Proceed to the **Yellow and White Lead Connections** section for the specific model.

2004 and Later Dyna Models

The garage door opener **switched** power source is an open fuse position on the fuse panel. See the FUSES section of the service manual and the correct wiring diagram in the service manual appendix.

1. Remove the electrical side cover, located on the left side of the motorcycle near the battery, by firmly grasping both sides and pulling outward.
2. Remove the electrical panel from the vehicle per service manual instructions.
3. See Figure 27. Get the orange/white fuse block adapter wire (12) from the kit. Note the terminal on each end (see Figure 17). Only the terminal with the spring tabs will fit into this fuse block. Carefully cut the unused terminal from the wire and discard it.
4. See Figure 18. Locate the fuse cavity (1) indicated as "OPEN" on the fuse block cover in the right fuse block.
Insert the terminal on the orange/white adapter wire until it stops. Refer to a nearby factory installed terminal for comparison to verify proper orientation and depth.

5. Pull **only** the orange/white wire out of the longer piece of conduit on the garage door opener wire harness. Cut the excess length from the orange/white wire to within easy reach of the adapter wire.
6. See Figure 15, the 1 into 1 splice configuration. Use a **blue** sealed splice connector (Figure 27, Item 5) from the kit to splice the garage door opener wire harness power lead to the adapter wire per the instructions in the service manual appendix.
7. See Figure 27. Install the 2A fuse (11) from the kit into the "OPEN" fuse cavity to complete the circuit.
8. Install the electrical panel per the instructions in the service manual. Install the electrical panel cover by aligning the pins with the rubber bushings in the electrical panel and pushing firmly into place.
9. Proceed to the **Yellow and White Lead Connections** section for the specific model.

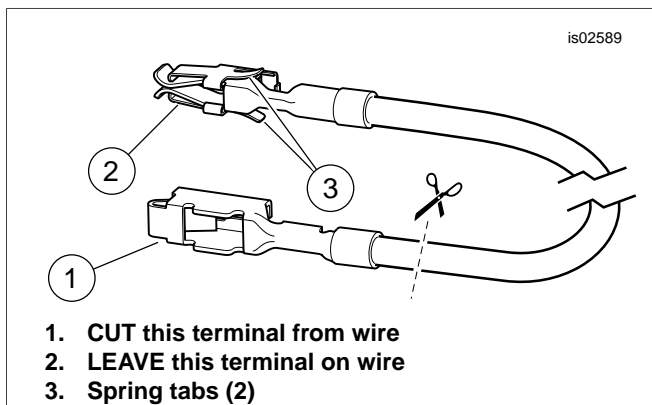

Figure 17. Fuse Block Adapter Wire (Dyna and Softail)

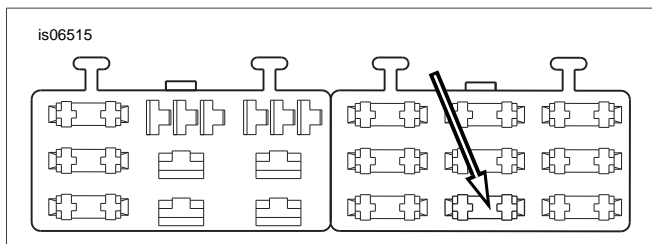

Figure 18. "OPEN" Fuse Block Cavity (2004 and Later Dyna)

2003 and Earlier Softail Models

The garage door opener **switched** power source is the orange/white (O/W) wire in the tail lamp harness under the seat.

1. See Figure 2. Carefully slice open an area of the tail lamp harness (1) wrap at an accessible point under the seat, and cut the orange/white wire.
2. Pull **only** the orange/white wire out of the longer piece of conduit on the garage door opener wire harness. Cut the excess length from the orange/white wire to within easy reach of the cut orange/white wires under the seat.
3. See Figure 15, the 2 into 1 splice configuration. Use a **red** sealed splice connector (Figure 27, Item 4) from the kit to splice the garage door opener wire harness power lead to the cut orange/white wires per the instructions in the service manual appendix.

4. Proceed to the **Yellow and White Lead Connections** section for the specific model.

2004-2010 Softail Models

The garage door opener **switched** power source is an open fuse position on the fuse panel. See the FUSES section of the service manual and the correct wiring diagram in the service manual appendix.

1. Remove the fuse block cover. Remove the two hex head screws fastening the fuse block bracket, and pull the bracket and fuse block assembly away from the vehicle frame.
2. Press the tab retaining the left fuse block, and slide the block out of the mounting slots.
3. See Figure 27. Get the orange/white fuse block adapter wire (12) from the kit. Note the terminal on each end (see Figure 17). Only the terminal with the spring tabs will fit into this fuse block. Carefully cut the unused terminal from the wire and discard.
4. See Figure 19. Locate the fuse cavity (1) indicated as "P&A IGN" on the fuse block cover in the right fuse block. Insert the terminal on the orange/white adapter wire until it stops. Refer to a nearby factory installed terminal for comparison to verify proper orientation and depth.
5. Pull **only** the orange/white wire out of the longer piece of conduit on the garage door opener wire harness. Cut the excess length from the orange/white wire to within easy reach of the adapter wire.
6. See Figure 15, the 1 into 1 splice configuration. Use a **blue** sealed splice connector (Figure 27, Item 5) from the kit to splice the garage door opener wire harness power lead to the adapter wire per the instructions in the service manual appendix.
7. See Figure 27. Install the 2A fuse (11) from the kit into the "P&A IGN" fuse cavity to complete the circuit.
8. Slide the fuse block into the mounting slots in the fuse block bracket until it clicks firmly into place. Install the bracket and fuse block assembly into position and fasten with the two hex head screws removed earlier. Tighten securely.
9. Proceed to the **Yellow and White Lead Connections** section for the specific model.

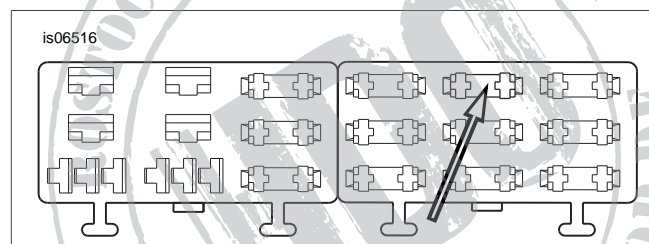

Figure 19. "P&A IGN" Fuse Block Cavity (2004-2010 Softail)

Sportster Models

The garage door opener **switched** power source is an orange/white (O/W) main harness power lead inside the electrical side cover or under the seat.

NOTE

On some Sportster models the ignition module must be removed to access the orange/white wire in the main harness.

1. See Figure 20. Carefully slice open an area of the main harness wrap inside the electrical side cover or under the seat at an accessible point, and cut an orange/white main harness power lead.

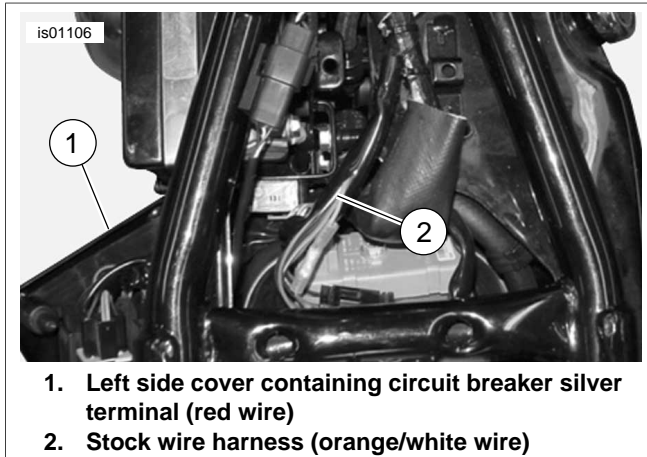

1. Left side cover containing circuit breaker silver terminal (red wire)
2. Stock wire harness (orange/white wire)

Figure 20. Power Connections (Sportster Models)

2. Pull **only** the orange/white wire out of the longer piece of conduit on the garage door opener wire harness. Cut the excess length from the orange/white wire to within easy reach of the cut orange/white wires inside the side cover or under the seat.
3. See Figure 15, the 2 into 1 splice configuration. Use a **red** sealed splice connector (Figure 27, Item 4) from the kit to splice the garage door opener wire harness power lead to the main harness orange/white wires per the instructions in the service manual appendix.
4. Proceed to the **Yellow and White Lead Connections** section for the specific model.

2002-2004 V-Rod Models

NOTE

Electrical connectors are identified in the service manual by the number and letter shown here within brackets.

1. See Figure 21 or Figure 22. Cut the orange/white main vehicle harness wire near the unused position lamp connector [29A] (1).
2. Pull **only** the orange/white wire out of the longer piece of conduit on the garage door opener wire harness. Cut the excess length from the orange/white wire to within easy reach of the cut orange/white wires at connector [29A].
3. See Figure 15, the 2 into 1 splice configuration. Use a **red** sealed splice connector (Figure 27, Item 4) from the kit to splice the garage door opener wire harness power lead to the main harness orange/white wires per the instructions in the service manual appendix.
4. Proceed to the **Yellow and White Lead Connections** section for the specific model.

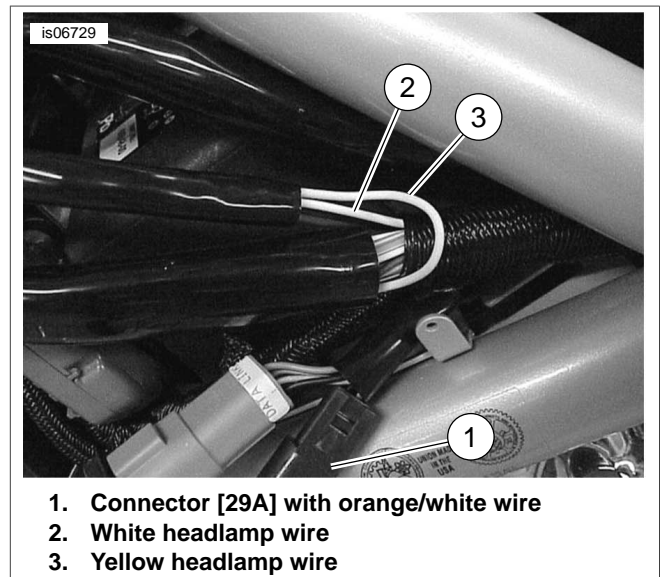

1. Connector [29A] with orange/white wire
2. White headlamp wire
3. Yellow headlamp wire

Figure 21. Wire Splice Locations (2002-2003 V-Rod)

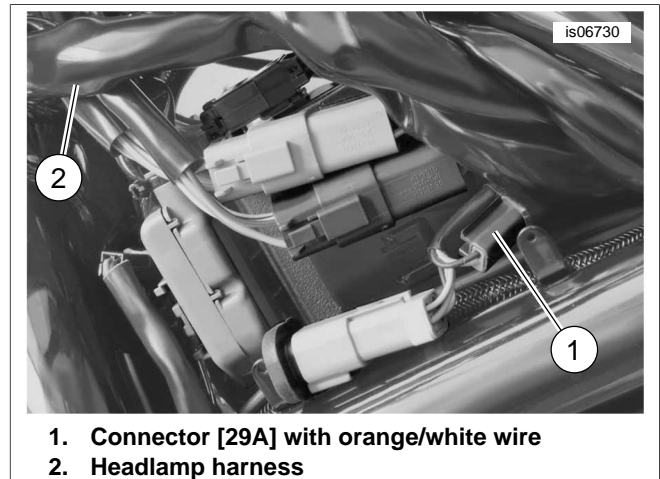

1. Connector [29A] with orange/white wire
2. Headlamp harness

Figure 22. Wire Splice Locations (2004 V-Rod)

2005 and Later V-Rod Models

NOTE

Electrical connectors are identified in the service manual by the number and letter shown here within brackets.

1. See Figure 23. Cut the orange/white **main vehicle harness** wire near the headlamp pin connector [38A] (1).
2. Pull **only** the orange/white wire out of the longer piece of conduit on the garage door opener wire harness. Cut the excess length from the orange/white wire to within easy reach of the cut orange/white wires at connector [38A].
3. See Figure 15, the 2 into 1 splice configuration. Use a **red** sealed splice connector (Figure 27, Item 4) from the kit to splice the garage door opener wire harness power lead to the main harness orange/white wires per the instructions in the service manual appendix.
4. Proceed to the **Yellow and White Lead Connections** section for the specific model.

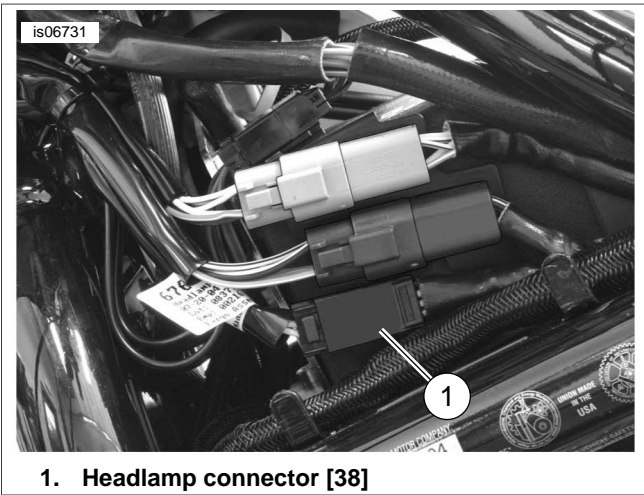

1. Headlamp connector [38]
Figure 23. Wire Splice Locations (2005 and Later V-Rod)

YELLOW AND WHITE LEAD CONNECTIONS TO HEADLAMP

Dyna Models

1. See Figure 24. Use cable straps from the kit to fasten the remaining transmitter wires (yellow and white) and conduit to the motorcycle wires leading to the headlamp. Lift the fuel tank as needed to feed the wires under the tank and toward the headlamp.

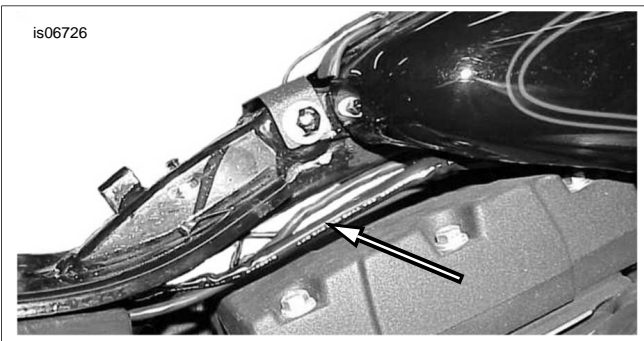

Figure 24. Transmitter Wire Routing to Headlamp (Dyna)

2. Route the wires into the headlamp housing through the grommet on the lower rear of the housing.

NOTE

To route the transmitter wires through the grommet, push a hooked piece of wire through the grommet from the inside of the headlamp housing.

A **light** coat of liquid soap, window cleaner or all-purpose lubricant may be needed to pull the wires back through the grommet with the hooked wire.

In some applications the transmitter wires may not fit through the headlight housing grommet. In that case, the wires must be spliced outside the headlamp housing.

3. Cut the yellow and white wires in the headlamp housing several inches from the headlamp connector. Cut excess length from the yellow and white transmitter wires if necessary. Cut to allow enough wire to easily strip and splice the wires.
4. See Figure 15, the 1 into 1 splice configuration. Use a **blue** sealed splice connector (Figure 27, Item 5) from the

kit to splice the white transmitter wire to the white headlamp wires. Use the remaining blue sealed splice connector to splice the yellow transmitter wire to the yellow headlamp wires.

5. Proceed to the **Receiver and Transmitter Programming** section to program the garage door opener controls.

Softail Models

1. Use cable straps from the kit to fasten the remaining transmitter wires (yellow and white) and conduit to the motorcycle wires leading to the headlamp. Lift the fuel tank as needed to feed the wires under the tank and toward the headlamp.

NOTE

For 2011 and later Softail models, the headlamp circuit wires in the vehicle harness are blue with a white or yellow tracer, rather than solid white and solid yellow as described in the following steps.

2. Cut the yellow and white wires in the main vehicle harness headlamp circuit at an accessible point. Cut excess length from the yellow and white transmitter wires if necessary. Trim back the transmitter wire harness casing as needed to assist splicing. Cut to allow enough wire to easily strip and splice the wires.
3. Slide the woven wire conduit (9) from the kit over the yellow and white transmitter wires.
4. See Figure 15, the 1 into 1 splice configuration. Use a **blue** sealed splice connector (Figure 27, Item 5) from the kit to splice the white transmitter wire to the white headlamp wires. Use the remaining blue sealed splice connector to splice the yellow transmitter wire to the yellow headlamp wires.
5. Slide the woven wire conduit over the yellow and white wire connections after splicing.
6. Proceed to the **Receiver and Transmitter Programming** section to program the garage door opener controls.

Sportster Models

1. Route the remaining transmitter wires (yellow and white) and conduit through the top of the frame under the fuel tank and up to the headlamp. Use cable straps from the kit to fasten the wires to the harness.
2. Route the wires into the headlamp housing through the grommet on the lower rear of the housing.

NOTE

To route the transmitter wires through the grommet, push a hooked piece of wire through the grommet from the inside of the headlamp housing.

A **light** coat of liquid soap, window cleaner or all-purpose lubricant may be needed to pull the wires back through the grommet with the hooked wire.

In some applications the transmitter wires may not fit through the headlight housing grommet. In that case, the wires must be spliced outside the headlamp housing. See Figure 25.

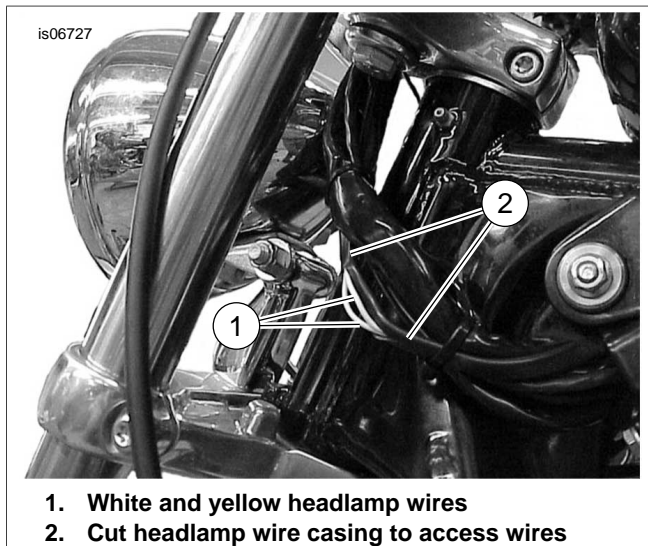

Figure 25. White and Yellow Wire Optional External Splice Location (Sportster Models)

3. Cut the yellow and white wires in the headlamp housing several inches from the headlamp connector. Cut excess length from the yellow and white transmitter wires if necessary. Cut to allow enough wire to easily strip and splice the wires.
4. See Figure 15, the 1 into 1 splice configuration. Use a **blue** sealed splice connector (Figure 27, Item 5) from the kit to splice the white transmitter wire to the white head-

lamp wires. Use the remaining blue sealed splice connector to splice the yellow transmitter wire to the yellow headlamp wires.

5. Proceed to the **Receiver and Transmitter Programming** section to program the garage door opener controls.

V-Rod Models

1. Cut the yellow and white wires in the main vehicle harness headlamp circuit at an accessible point several inches from the headlamp connector. Cut excess length from the yellow and white transmitter wires if necessary. Trim back the transmitter wire harness casing as needed to assist splicing. Cut to allow enough wire to easily strip and splice the wires.
2. See Figure 27. Slide the woven wire conduit (9) from the kit over the yellow and white transmitter wires.
3. See Figure 15, the 1 into 1 splice configuration. Use a **blue** sealed splice connector (Figure 27, Item 5) from the kit to splice the white transmitter wire to the white headlamp wires. Use the remaining blue sealed splice connector to splice the yellow transmitter wire to the yellow headlamp wires.
4. Slide the woven wire conduit over the yellow and white wire connections after splicing.
5. Install the front left louvered cover onto the motorcycle.
6. Proceed to the **Receiver and Transmitter Programming** section to program the garage door opener controls.



RECEIVER AND TRANSMITTER PROGRAMMING

After the receiver and transmitter are installed, the receiver must be programmed to receive the transmitter frequency. This process may require two people, depending upon how far apart the receiver and transmitter are during the programming process.

NOTE

Verify that the ignition key switch is in the OFF position **before** installing the main fuse or attaching the negative battery cable.

1. **Models with main fuse:** Refer to the service manual and follow the instructions to install the main fuse.
Models with main circuit breaker: Refer to the service manual and follow the instructions to attach the negative battery cable.
Apply a light coat of Harley-Davidson electrical contact lubricant (Part No. 99861-02), petroleum jelly or corrosion retardant material to the negative battery terminal.
2. Check that a red LED is illuminated on the front of the Harley-Davidson garage door opener **receiver** (in the garage), indicating power to the receiver.
3. See Figure 26. Press and hold the SET button on the Harley-Davidson garage door opener **receiver**. The LED on the **transmitter** (on the vehicle) blinks continuously while the SET button is pressed.

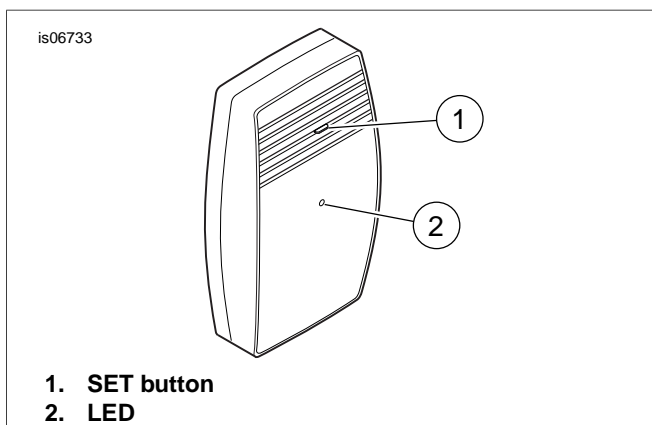

Figure 26. Garage Door Opener Receiver, Front View

4. Turn the ignition key switch to IGNITION, but do not start the vehicle. Operate the headlamp beam switch using one of these sequences:
 - With the headlamp on LO beam, switch to HI, then LO.
 - With the headlamp on HI beam, switch to LO, then HI.

When the **receiver** acquires a signal from the transmitter, the LED on the **transmitter** turns off.

5. Release the SET button on the receiver.

WARNING

Be sure that all lights and switches operate properly before operating motorcycle. Low visibility of rider can result in death or serious injury. (00316a)

NOTE

Clear all obstructions away from between the transmitter and receiver before testing the operation of the garage door opener.

6. Test the garage door opener, and headlamp high beam and low beam operation.

NOTE

When the transmitter is activated by toggling the headlamp switch, the red LED on the transmitter illuminates for one second to indicate that the transmitter is functioning correctly.

WARNING

After installing seat, pull upward on seat to be sure it is locked in position. While riding, a loose seat can shift causing loss of control, which could result in death or serious injury. (00070b)

7. Refer to the service manual, and follow instructions to install or close the seat.
8. Turn the ignition key switch to OFF.
9. Install any parts that were removed for transmitter installation.

TROUBLESHOOTING

Headlamp Switch Toggled, but Garage Door Opener Does Not Function.

With the ignition key switch turned to IGNITION:

1. Does the LED on the **vehicle** transmitter flash when the headlamp switch is toggled?
 - **YES.** Proceed to Step 2.
 - **NO.** Proceed to Step 3.
2. Does the LED on the **garage**-mounted receiver flash **once** when the signal is transmitted from the vehicle?
 - **YES.** Proceed to Step 4.
 - **NO.** Proceed to **Reset the Receiver**.
3. Verify proper connections to the vehicle power wires, headlamp wires and ground.
4. See **Receiver Installation** near the front of these instructions.
 - a. Verify that the receiver is **properly wired** to the existing garage door opener unit.
 - b. Verify that the receiver is **spaced a sufficient distance** from the existing garage door opener receiver.

Reset the Receiver

1. Unplug the receiver from the 110 Volt power outlet.
2. Wait ten seconds.
3. **Press and hold** the program button on the receiver. While holding the button down, plug the receiver into the power outlet. The red LED will flash rapidly.
4. Release the program button. The receiver is now reset, and all memory is erased.
5. Program the receiver again. See the **Receiver and Transmitter Programming** section earlier in these instructions.

SERVICE PARTS

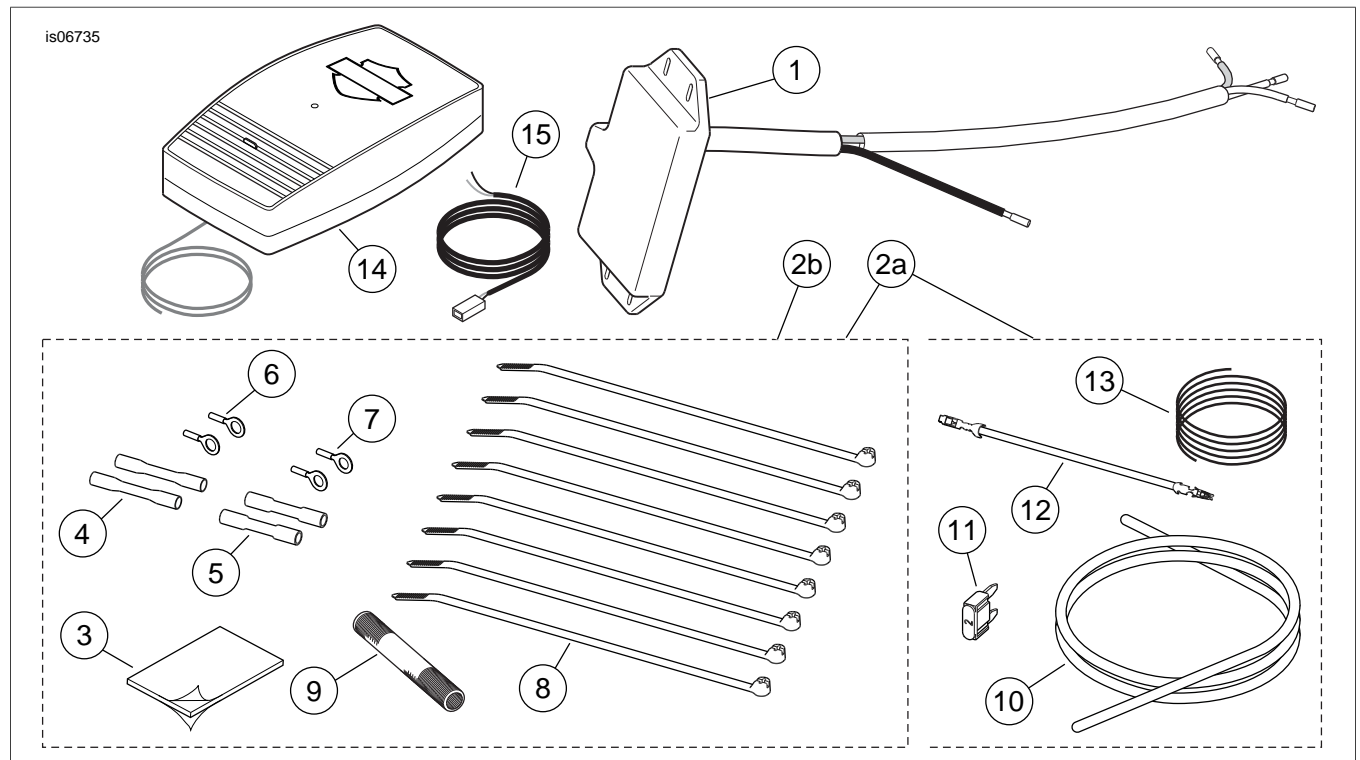

Figure 27. Service Parts, Remote Control Garage Door Opener Kits

Table 1. Service Parts, Garage Door Opener Kit 91558-01A

Item	Description (Quantity)	Part Number
1	Transmitter assembly	Not sold separately
2a	Hardware kit (includes items 3 through 13)	91650-01A
3	• Foam tape, double-sided, 1.0 inch (25.4 mm) x 1.5 inch (38.1 mm)	Not sold separately
4	• Sealed splice connector, #18-20 AWG (red) (2)	70585-93
5	• Sealed splice connector, #14-16 AWG (blue) (2)	70586-93
6	• Ring Terminal, #18-22 AWG, for 5/16 inch (7.9 mm) stud	9859
7	• Ring Terminal, #18-22 AWG, for 1/4 inch (6.4 mm) stud	9858
8	• Cable strap, black, 7.75 inch (20 cm) long (8)	10006
9	• Wire conduit, woven polyester, 3.0 inch (76 mm) long	70599-02
10	• Wire conduit, #8 x 2.75 ft. (0.84 M) long (for 2004 and later V-Rod models)	Not sold separately
11	• Fuse, blade type, 2 Amp	54305-98
12	• Fuse block adapter wire, orange/white	70329-04
13	• Wire, insulated, black, #20 AWG, 34 inch (0.86 M) long	Not sold separately
14	Receiver assembly	91560-01
15	Receiver cable assembly	Not sold separately

SERVICE PARTS

Table 2. Service Parts, Transmitter Kit 91561-01

Item	Description (Quantity)	Part Number
1	Transmitter assembly	Not sold separately
2b	Hardware kit (includes items 3 through 9)	91650-01
3	• Foam tape, double-sided, 1.0 inch (25.4 mm) x 1.5 inch (38.1 mm)	Not sold separately
4	• Sealed splice connector, #18-20 AWG (red) (2)	70585-93
5	• Sealed splice connector, #14-16 AWG (blue) (2)	70586-93
6	• Ring Terminal, #18-22 AWG, for 5/16 inch (7.9 mm) stud	9859
7	• Ring Terminal, #18-22 AWG, for 1/4 inch (6.4 mm) stud	9858
8	• Cable strap, black, 7.75 inch (20 cm) long (8)	10006
9	• Wire conduit, woven polyester, 3.0 inch (76 mm) long	70599-02

Table 3. Service Parts, Receiver Kit 91562-01

Item	Description (Quantity)	Part Number
14	Receiver assembly	91560-01
15	Receiver cable assembly	Not sold separately

