



INSTRUCTIONS

-J03758

REV. 2006-09-15

LEATHER TOUR-PAK LOCK

GENERAL

Kit Number

54360-05

Models

For model fitment information, please see the P&A Retail Catalog or the Parts and Accessories section of www.harley-davidson.com (English Only).

Additional Parts Required

WARNING

The rider's safety depends upon the correct installation of this kit. If the procedure is not within your capabilities or you do not have the correct tools, have a Harley-Davidson dealer perform the installation. Improper installation of this kit could result in death or serious injury. (00308a)

Kit Contents

See Figure 9 and Table 1.

INSTALLATION

NOTE

Be careful not to damage the leather surface when installing this kit. For best results, use a clean pad or blanket on the work surface to protect the Tour-Pak leather surfaces.

Install Upper Mounting Bracket

1. Refer to the appropriate Instruction Sheet to remove the Tour-Pak from the vehicle.
2. See Figure 1. Using a 3/16 in. (4.8 mm) diameter drill bit, carefully drill out the four rivets that hold the leather straps to the Tour-Pak lid. Then open up holes with a 7/32 in. (5.6 mm) diameter drill.

Kit 53057-07 Only: There are no straps to remove in this kit. Open up Tour-Pak and locate the four holes on the inside of the lid. Carefully pierce through the leather from the inside using an awl or #8 nail in the center of the four hole locations. After piercing the leather, carefully drill through the pierced holes using a 3/16 in. (4.8 mm) drill from the outside of the Tour-Pak.

3. Remove existing four flange nuts from cushion inside Tour-Pak. Save for reuse.
4. See Figure 2. Place upper mounting bracket (1) directly against the underside of the Tour-Pak lid.
5. Place leather straps (2) directly on upper mounting bracket.

NOTE

Do not place leather straps between Tour-Pak lid and upper mounting bracket.

6. Secure using four rivet posts and screws (3). Tighten screws securely.

Tour-Pak 53057-07 Only: Install leather loops included in the Tour-Pak kit using Step 4.

7. Fasten upper mounting bracket to cushion inside Tour-Pak using four flange nuts (4) previously removed.

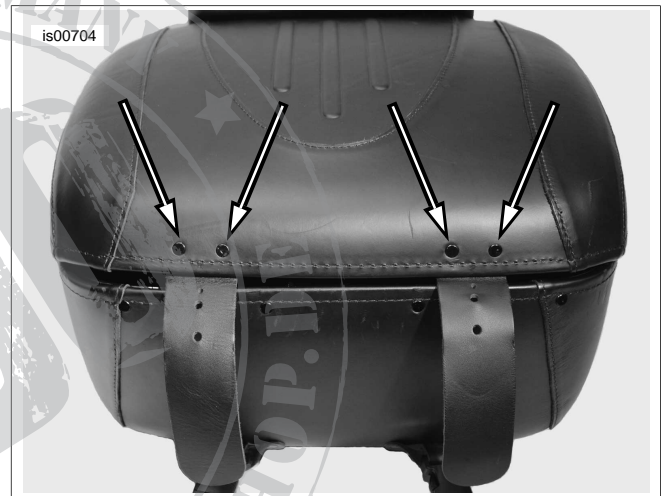

Figure 1. Location of Original Equipment Rivets

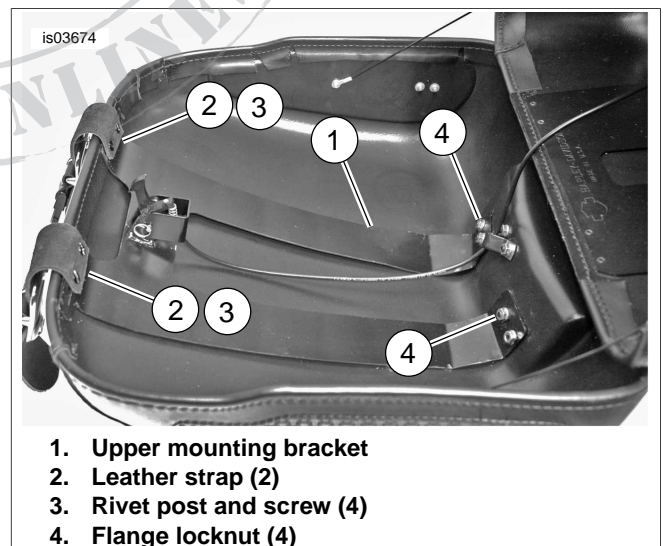

Figure 2. Install Upper Mounting Bracket

Install Lower Mounting Bracket

1. See Figure 3. Position lower mounting bracket (1) to inside of Tour-Pak base. Lightly clamp the lower mounting bracket to the Tour-Pak base to hold it in place.
2. Using a 1/8 in. (3.2 mm) diameter drill bit, carefully drill six holes in Tour-Pak base. Then open up holes with a 7/32 in. (5.6 mm) diameter drill.
3. Install lower mounting bracket using six rivets and screws (2). Tighten screws securely.

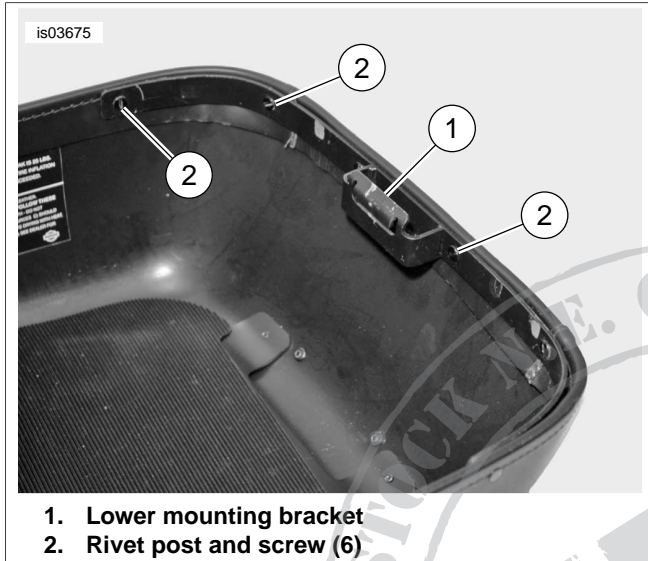

Figure 3. Install Lower Mounting Bracket

Install Lock Set Components

1. See Figure 9. Position lock set template (16) in front-right corner on underside of Tour-Pak and tape it into place.
2. Drill four 3/16 in. (4.8 mm) holes in Tour-Pak where indicated on the template.
3. Drill four 5/32 in. (4.0 mm) holes in Tour-Pak where indicated on the template.
4. Remove template. Cut out the area in between the four smaller holes to create a rectangular opening for the lock set rod.
5. Stand Tour-Pak upright on right side, with lid open.
6. Place lock set into rectangular opening previously cut.
7. Insert two screws (1) through lock set mounting holes and into Tour-Pak.
8. Install lock set (2) and backing plate (3) using two lock-washers (4) and hex nuts (5) from kit.
9. Using a 3/16 in. (4.8 mm) hex wrench, remove two screws (6) and cover (7).

Install Cable Assembly

1. See Figure 4. Trim the front-right corner of the rubber mat with a box cutter or scissors to allow the cable assembly to be installed.

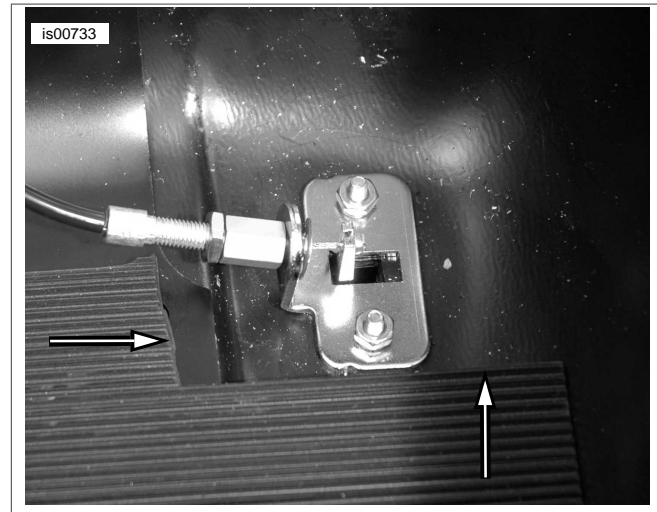

Figure 4. Trim Rubber Mat

WARNING

Wear safety glasses or goggles when removing or installing retaining rings. Retaining rings can slip from the pliers and could be propelled with enough force to cause serious eye injury. (00312a)

NOTE

Make sure you are using the correct retaining ring pliers. Verify that tips of pliers are not excessively worn or damaged.

2. See Figure 5. Remove retaining ring at adjustment nut end of cable assembly.
3. Insert cable end through hole in lock set backing plate (1), and insert cable (2) into slot in lock set rod (3) so ball on end of cable (4) holds it in place.
4. Install retaining ring (5) into cable fitting groove.

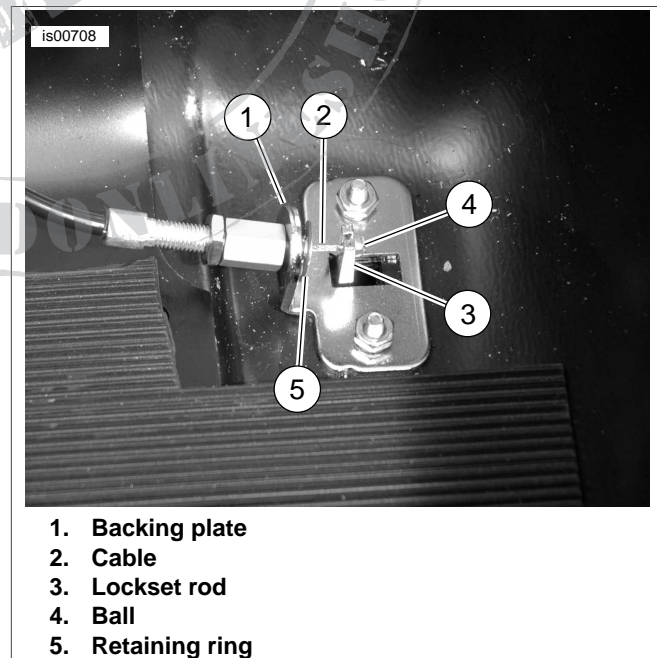

Figure 5. Install Cable Assembly

5. See Figure 9. Install cover (7) over lock set rod and cable end using two screws (6).

- See Figure 6. Install clamp (1) at bottom of Tour-Pak lid (2) using locknut (3) to ensure proper routing of cable (4). Tighten locknut snugly.

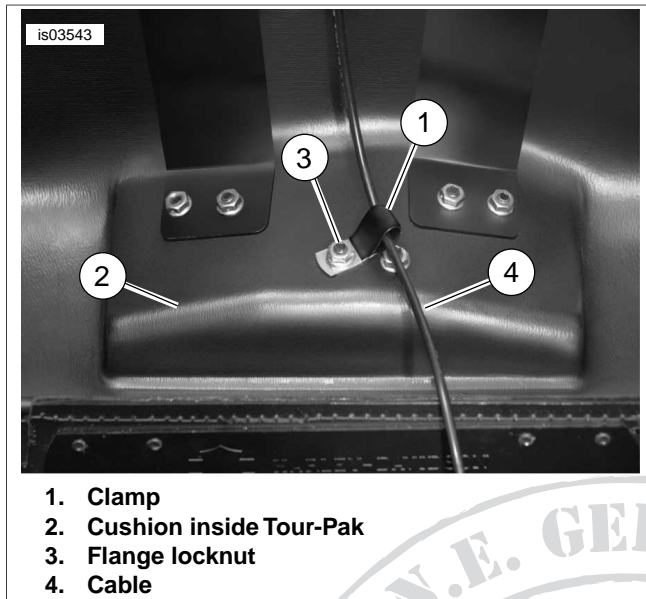

Figure 6. Clamp and Cable Routing

- Close and open Tour-Pak lid several times to verify that it locks every time. Adjust if necessary.

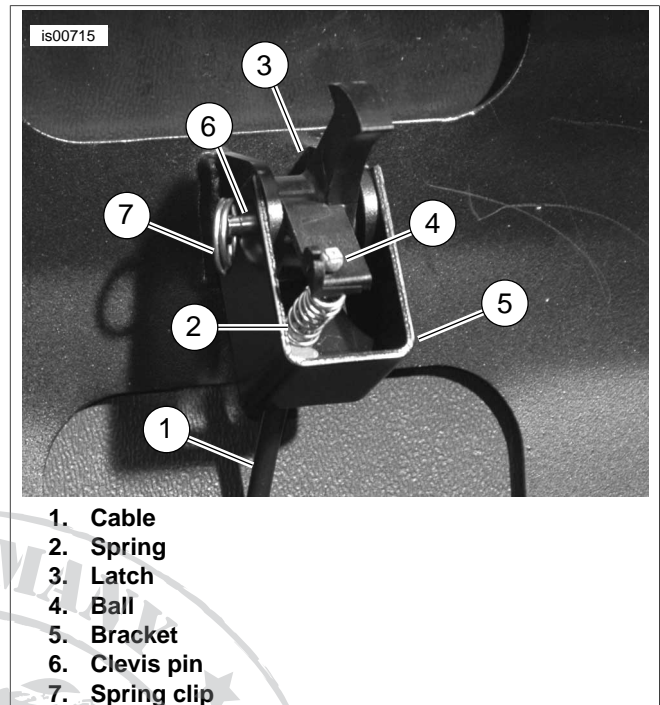

Figure 7. Install Latch and Spring Kit

Install Latch and Spring Kit

- See Figure 7. Insert free end of cable (1) through spring (2), and insert cable into slot in the latch (3) so ball on end of cable (4) holds it in place.
- Position latch inside tabs of Tour-Pak lid, and latch bracket (5) outside tabs, lining up holes. Insert clevis pin (6) through holes, and fasten with spring clip (7).
- See Figure 9. Insert key (8) into lock set (2), and turn to unlock if necessary. Press key inward and check latch for proper operation. Adjust cable assembly if necessary.
- Close the Tour-Pak lid.
- Refer to the appropriate Instruction Sheet to install the Tour-Pak on the vehicle.

Adjust Cable Assembly

- See Figure 8. Back jam nut (1) away from body hex (2).
- Turn body hex toward or away from jam nut as needed to adjust cable assembly.
- Turn jam nut until it makes contact with body hex.

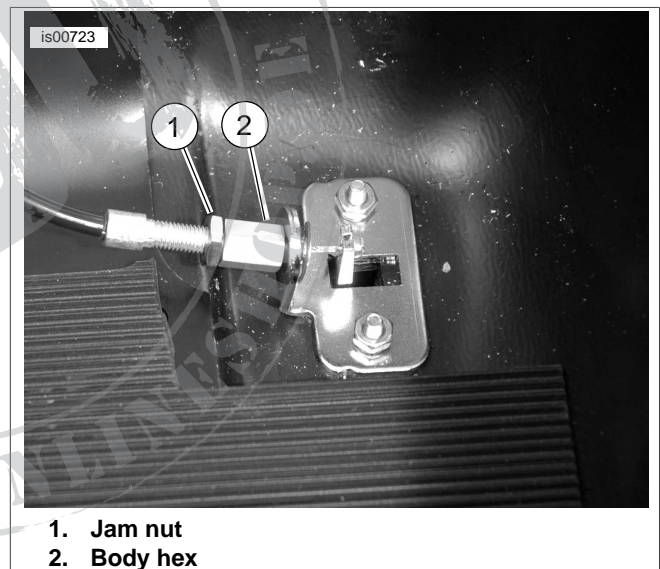

Figure 8. Adjust Cable Assembly

SERVICE PARTS

is03535

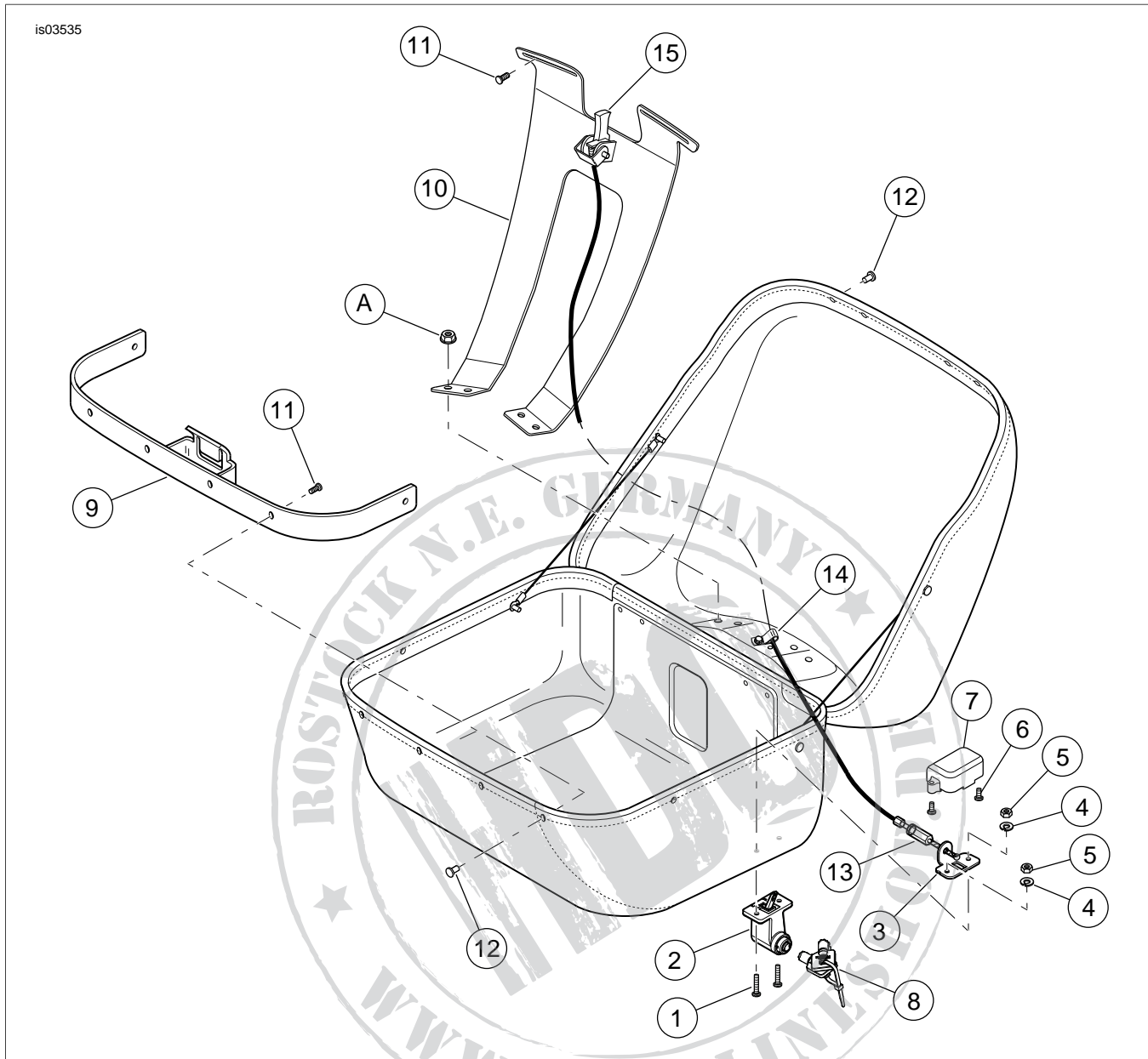

Figure 9. Service Parts: Leather Tour-Pak Lock

Table 1. Service Parts: Leather Tour-Pak Lock

Item	Description (Quantity)	Part Number
1	Screw, #8-32 x 3/4 in. (2)	2646
2	Lock set	Not Sold Separately
3	Backing plate	Not Sold Separately
4	Lockwasher, #8 (2)	7015
5	Hex nut, #8-32 (2)	7517
6	Screw, Hi-Lo #6-19 (2)	2325
7	Cover	Not Sold Separately
8	Key (2) (specify key code)	71452-91A/xxxx
9	Bracket, lower mounting	Not Sold Separately
10	Bracket, upper mounting	Not Sold Separately
11	Rivet screw, #8-32 x .38 (15)	8567

Table 1. Service Parts: Leather Tour-Pak Lock

Item	Description (Quantity)	Part Number
12	Rivet post, #8-32 (15)	8564
13	Cable assembly	Not Sold Separately
14	Clamp	10076
15	Latch and spring kit	91411-04
16	Lock set template (not shown)	Not Sold Separately
Original equipment parts mentioned in text, but not included in kit:		
A	Flange locknut (6)	

