



# INSTRUCTIONS

-J04284

REV. 2007-07-26

## MODULAR DIAMONDBACK BRAKE LINE KITS

### GENERAL

#### Kit Number

Table 1. Upper Brake Line Kits (Banjo Angle 0° - Straight)

Kit Number	Length	Kit Number	Length
42373-07	18 inch	44962-07	25 inch
42377-07	19 inch	42749-07	26 inch
42379-07	20 inch	42752-07	28 inch
42385-07	21 inch	42754-07	30 inch
42387-07	22 inch	42756-07	32 inch
42395-07	23 inch	44953-07	34 inch
42485-07	24 inch		

Table 2. Upper Brake Line Kits - Banjo Angle 35°

Kit Number	Length	Kit Number	Length
42758-07	18 inch	44964-07	25 inch
42760-07	19 inch	42772-07	26 inch
42762-07	20 inch	42774-07	28 inch
42764-07	21 inch	42776-07	30 inch
42766-07	22 inch	42778-07	32 inch
42768-07	23 inch	44955-07	34 inch
42770-07	24 inch		

Table 3. Upper Brake Line Kits - Banjo Angle 90°

Kit Number	Length	Kit Number	Length
42780-07	18 inch	44966-07	25 inch
42782-07	19 inch	42905-07	26 inch
42784-07	20 inch	42907-07	28 inch
42786-07	21 inch	42909-07	30 inch
42788-07	22 inch	42911-07	32 inch
42791-07	23 inch	44957-07	34 inch
42903-07	24 inch		

#### NOTE

*Diamondback™ Upper Brake Line Kits are available in a variety of master cylinder banjo angles and brake line lengths. Shorter or longer lines may be necessary when modifications (i.e., optional handlebars) have been made to the motorcycle. See the P&A Retail Catalog or a Harley-Davidson dealer for more information.*

Table 4. Lower Brake Line Kits

Kit Number	Length	Caliper Banjo Angle
42371-07	20.25 in.	78°
42110-07	21.5 in.	78°
42366-07	22.75 in.	78°
45770-08	23.25 in.	78°
42108-07	24.0 in.	78°

#### Models

For model fitment information, please see the P&A Retail Catalog or the Parts and Accessories section of [www.harley-davidson.com](http://www.harley-davidson.com) (English only).

#### Tools and Supplies Required

Fresh, uncontaminated brake fluid will be needed. Refer to your Owner's Manual or the Service Manual for this year and model motorcycle to determine the correct brake fluid for this vehicle.

#### WARNING

**Brakes are a critical safety component. Contact a Harley-Davidson dealer for brake repair or replacement. Improperly serviced brakes can adversely affect brake performance, which could result in death or serious injury. (00054a)**

#### WARNING

**The rider's safety depends upon the correct installation of this kit. Use the appropriate service manual procedures. If the procedure is not within your capabilities or you do not have the correct tools, have a Harley-Davidson dealer perform the installation. Improper installation of this kit could result in death or serious injury. (00333a)**

#### NOTE

*This instruction sheet references Service Manual information. A Service Manual for your model motorcycle is required for this installation and is available from a Harley-Davidson dealer.*

## Kit Contents

See Table 5 and Table 6.

## INSTALLATION

### Preparation

Models WITH Maxi® Fuse:

#### WARNING

To prevent accidental vehicle start-up, which could cause death or serious injury, remove maxi-fuse before proceeding. (00251a)

1. Refer to the Service Manual and follow the instructions given to remove the Maxi® Fuse.

Models WITHOUT Maxi® Fuse:

#### WARNING

To prevent accidental vehicle start-up, which could cause death or serious injury, disconnect battery cables (negative (-) cable first) before proceeding. (00307a)

#### WARNING

Disconnect negative (-) battery cable first. If positive (+) cable should contact ground with negative (-) cable connected, the resulting sparks can cause a battery explosion, which could result in death or serious injury. (00049a)

1. Refer to the Service Manual and follow the instructions given to remove the seat and disconnect the battery cables, negative cable first. Retain all seat mounting hardware.

#### CAUTION

Direct contact of D.O.T. 5 brake fluid with eyes can cause eye irritation, swelling, and redness. Avoid eye contact. In case of eye contact flush with large amounts of water and get medical attention. Swallowing large amounts of D.O.T. 5 brake fluid can cause digestive discomfort. If swallowed, obtain medical attention. Use in well ventilated area. KEEP OUT OF REACH OF CHILDREN. (00144a)

#### CAUTION

Direct contact of D.O.T. 4 brake fluid with eyes can cause irritation. Avoid eye contact. In case of eye contact flush with large amounts of water and get medical attention. Swallowing large amounts of D.O.T. 4 brake fluid can cause digestive discomfort. If swallowed, obtain medical attention. Use in well ventilated area. KEEP OUT OF REACH OF CHILDREN. (00240a)

#### CAUTION

D.O.T. 4 brake fluid will damage painted and body panel surfaces it comes in contact with. Always use caution and protect surfaces from spills whenever brake work is performed. Failure to comply can result in cosmetic damage. (00239b)

#### NOTE

Immediately wipe up any brake fluid spillage with a clean, dry, soft cloth. Follow up by thoroughly wiping affected area with a clean, damp, soft cloth (small spills) or washing with a large quantity of soapy water (large spills).

2. Drain the brake fluid from the front brake reservoir and lines per the instructions in the Service Manual.

### Original Front Brake Line Removal

#### NOTE

Cover the front fender and the front of the fuel tank with clean shop towels to prevent scratching. Damage to the finish could result.

#### CAUTION

Remove brake line components carefully. Damage to seating surfaces can cause leakage. (00320a)

3. Disconnect the front brake line from the front brake master cylinder and front brake caliper. Save the master cylinder and caliper banjo bolts. Discard all sealing washers.

#### NOTE

FXCW and FXCWC models do not use P-clamps, screws or washers to retain the original brake line.

4. For all models except FXCW and FXCWC: Remove the existing P-clamps and mounting hardware retaining the original brake line at the following locations:
  - a. Under the lower triple clamp.
  - b. Along the right side of the steering head at the upper triple clamp and/or between the upper and lower triple clamps.

Save the mounting hardware for later installation. Discard the P-clamps.

5. For all models EXCEPT FXCW and FXCWC: Carefully make note of the front brake line routing and orientation of the banjo fittings, then remove the existing front brake line.

For FXCW and FXCWC models: Carefully make note of the orientation of the banjo fittings, then remove the existing front brake line.

### Braided Front Brake Line Installation

#### CAUTION

Avoid leakage. Be sure gaskets, banjo bolt(s) and brake line are clean and undamaged before assembly. (00323a)

6. Verify that the correct upper and lower Brake Line Kits have been obtained.
  - In some cases, the Upper Brake Line Kit has already been specified.
  - In other cases, the proper Upper Brake Line Kit (see Table 1, Table 2, or Table 3) needs to be determined using the Cable and Brake Line Measurement Tool Kit. See a Harley-Davidson dealer for assistance.
  - See Table 4 to determine the correct Lower Brake Line Kit for your model motorcycle.

**WARNING**

**Replace brake line gaskets. Re-using original gaskets can cause brake failure and loss of vehicle control, which could result in death or serious injury. (00318a)**

7. See Figure 1. Install the banjo fitting (1) of the upper brake line (2) at the master cylinder (3), using the larger I.D. sealing washers (4) from the Upper Brake Line Kit on each side of the banjo fitting.
8. Install the master cylinder banjo bolt (5, saved earlier) snug, but do not fully tighten at this time.

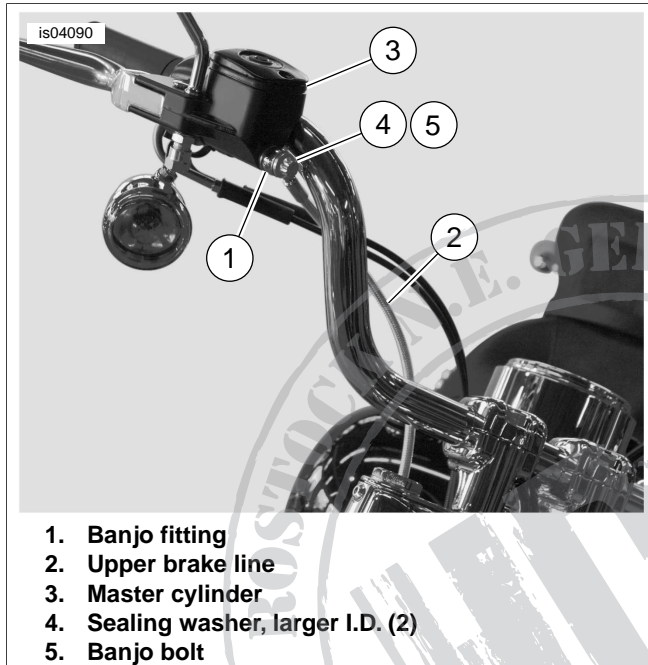

1. Banjo fitting
2. Upper brake line
3. Master cylinder
4. Sealing washer, larger I.D. (2)
5. Banjo bolt

**Figure 1. Upper Brake Line (FLSTF Shown)**

9. See Figure 2. Install the banjo fitting (1) of the lower brake line (2) at the caliper (3), using the smaller I.D. sealing washers (4) from the Lower Brake Line Kit on each side of the banjo fitting.
  - a. Position the banjo fitting away from vehicle at an angle of approximately 10° from vertical.
  - b. Install the caliper banjo bolt (5, saved earlier), and tighten to 17-22 ft-lbs (23-30 Nm).
10. See Figure 3. Route the remainder of the lower brake line under the lower triple clamp.

**For all models except FXCW and FXCWC:** Continue at Step 11.  
**For FXCW and FXCWC models:** Continue at Step 14.

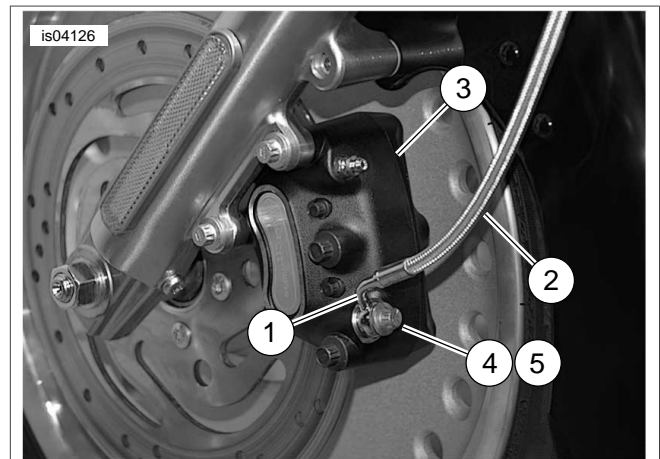

1. Banjo fitting
2. Lower brake line
3. Caliper
4. Sealing washer (2)
5. Banjo bolt

**Figure 2. Lower Brake Line (FLSTF Shown)**

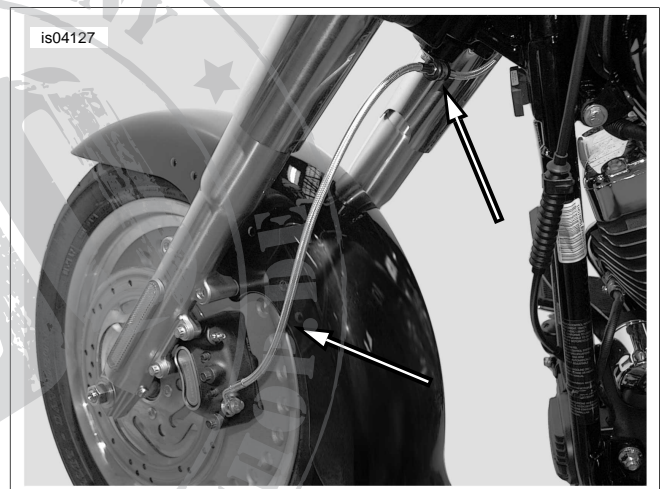

**Figure 3. Lower Brake Line Routing (FLSTF Shown)**

**Upper Front Brake Line Routing (Except FXCW and FXCWC)**

11. Route the upper portion of the upper brake line along the handlebars (similar to the routing shown in Figure 1), then:
  - a. **For Dyna and FX Softail models,** install a small P-clamp from the kit onto the brake line at the location shown in Figure 4.
  - b. **For FL Softail models,** install two small P-clamps from the kit onto the brake line at the locations shown in Figure 5.

**NOTE**

*The P-clamp(s) typically must be oriented so the brake line is held away from the vehicle. However, some custom handlebar applications may require the P-clamp to be oriented so the brake line is held toward the vehicle.*

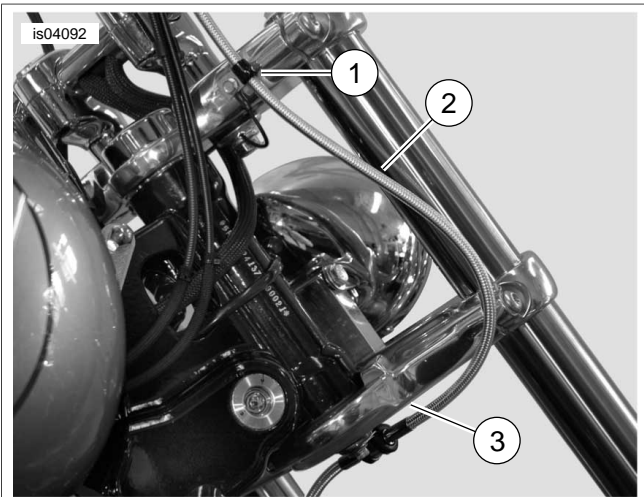

1. P-clamp
2. Upper brake line
3. Lower triple clamp

Figure 4. Upper Brake Line Routing (One P-Clamp)

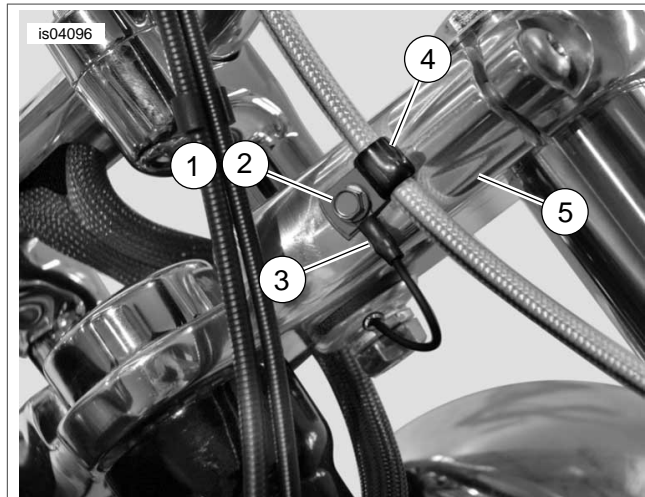

1. Screw
2. Star washer
3. Ground lug
4. P-clamp
5. Upper triple clamp

Figure 6. Electrical Ground Lug Mounting (Dyna Models and FX Softails except FXCW and FXCWC)

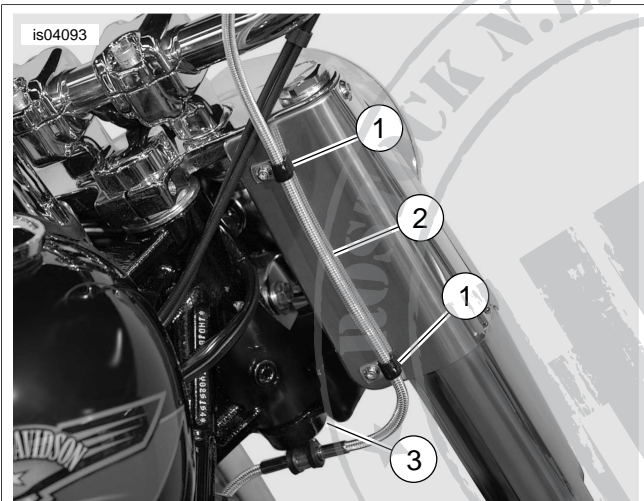

1. P-clamp (2)
2. Upper brake line
3. Lower triple clamp

Figure 5. Upper Brake Line Routing (Two P-Clamps)

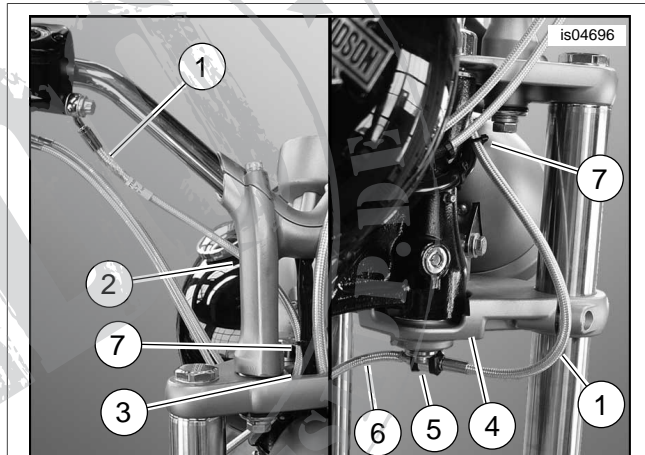

1. Upper brake line
2. Right-side handlebar riser
3. Middle opening of upper triple clamp
4. Lower triple clamp
5. Cushioned P-clamp
6. Lower brake line
7. Cable strap (2)

Figure 7. Upper Front Brake Line Routing (FXCW and FXCWC)

#### Upper Front Brake Line Routing (FXCW and FXCWC)

14. See Figure 7. Route the upper brake line (1) behind the handlebar riser (2) and through the middle opening (3) of the upper triple clamp. Loop the brake line outward behind the right fork and under the lower triple clamp (4).

#### Upper/Lower Front Brake Line Connection (ALL Models)

15. Hold the upper brake line female fitting (with swivel nut) underneath the lower triple clamp, approximately at the P-clamp threaded mounting hole location. Bring the lower

12. For Dyna and FX Softail models: See Figure 6. Obtain the P-clamp screw (1) and star washer (2) removed earlier. Place the washer onto the screw threads, followed by the electrical ground lug (3) and a **new** small P-clamp (4) from the Upper Brake Line Kit.

Loosely install the screw into the upper triple clamp (5) so brake line adjustments can still be made.

**For FL Softail models,** Obtain the P-clamp mounting hardware removed earlier, and loosely install the clamps to the right-rear back panel so brake line adjustments can still be made.

13. See Figure 4 or Figure 5. Route the remainder of the upper brake line under the lower triple clamp. Proceed to Step 15.

brake line male fitting to meet the upper brake line female fitting.

16. Thread the male and female fittings together by turning the swivel nut on the female fitting.
  - a. Turn until finger tight, being careful not to twist the upper or lower brake lines while tightening.
  - b. Then, using two 7/16 in. open-end wrenches, tighten the nut 1/4 to 1/2 additional turn.

17. Obtain the cushioned P-clamp from the Upper Brake Line Kit. Position the P-clamp to the underside of the lower triple clamp so the flat side of the clamp will be up against the bottom of the lower triple clamp, and

**for Dyna, FXCW/C and FX Softail models:** the loop of the cushioned clamp faces towards the **front** of the vehicle. See Figure 8.

**for FL Softail models:** the loop of the cushioned clamp faces towards the **rear** of the vehicle. See Figure 9

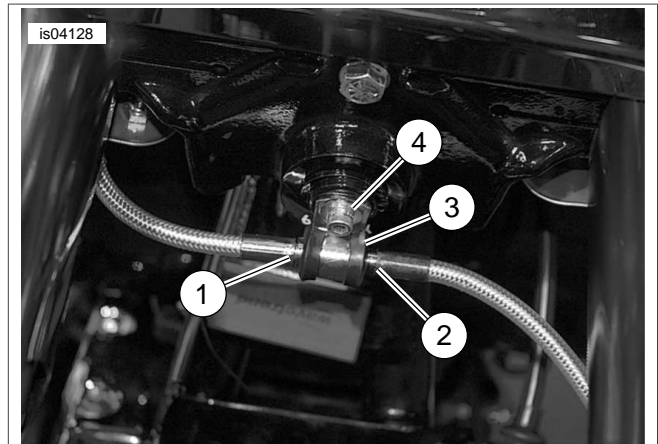

1. Female fitting with swivel nut
2. Male fitting
3. Cushioned P-clamp
4. Stock screw

**Figure 9. Cushioned P-Clamp Mount (Rearward Position)**

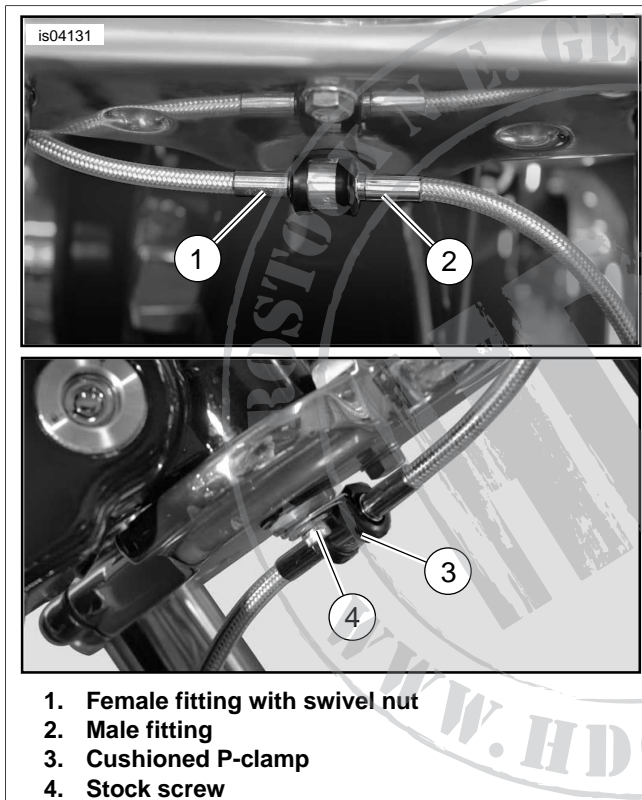

1. Female fitting with swivel nut
2. Male fitting
3. Cushioned P-clamp
4. Stock screw

**Figure 8. Cushioned P-Clamp Mount (Forward Position)**

18. Open the cushioned P-clamp far enough to place the loop over the fitting connection. Close the P-clamp around the connection, making sure the clamp overlaps both sides equally, and being careful not to twist the brake line.

19. **For all models except FXCW and FXCWC:** Mount the cushioned P-clamp using the original screw (4) previously removed.

**For FXCW and FXCWC models:** Mount the cushioned P-clamp using the **new** screw and flat washer from the Lower Brake Line Kit.

Tighten the screw to 8-10 ft-lbs (10.8-13.6 Nm).

### Brake Line Routing Check and Adjustment

20. Using a motorcycle lift, raise the vehicle frame so that the front forks reach maximum extension. Verify that the lower brake line is not pulled tight when the forks are fully extended.

21. Check the upper and lower brake line routing and banjo fitting orientation as follows:

- a. Verify that the lower brake line is of sufficient length to allow full fork extension without pulling the brake line.

- b. Fully compress the forks to check that the lower brake line does not interfere with motorcycle components.

- c. Turn the handlebars to the full left and full right fork stops to ensure smooth routing and proper slack in the brake lines, and to ensure the brake lines do not contact any vehicle components.

22. Adjust the brake lines and/or banjo fitting orientation if the routing does not look right, or if the brake lines interfere or catch on motorcycle components.

23. When adjustments are complete, tighten the master cylinder banjo bolt to 17-22 ft-lbs (23-30 Nm).

24. **For all models except FXCW and FXCWC:** See Figure 4 or Figure 5. Tighten the P-clamp screw(s) at the triple clamp while holding the P-clamp(s) and electrical ground lug (if applicable) in the proper orientation.

Install cable straps at the same locations as the original cable straps, if applicable.

**For FXCW and FXCWC models:** See Figure 8. Use the two cable straps (7) from the Lower Brake Line Kit to bind the upper brake line to the handlebar switch wire harness in the locations shown.

Make sure the brake line does not contact the electrical ground lug under the handlebar riser bolt.

#### NOTES

**For 2006 and later Dyna models with the ignition switch/key location at the front of the frame directly behind the steering head:**

*If the brake line contacts the key or key fob during full right turn of the handlebars, turn the cushioned clamp (located below the lower triple clamp) towards the left side of the vehicle to move the vertical portion of the brake line between the upper and lower clamps as far to the right as possible, to keep brake line away from the ignition key.*

*If the brake line contacts the lower triple clamp, then turn the cushioned clamp towards the right side of the vehicle to provide the necessary clearance*

## FINAL ASSEMBLY

### Bleed and Test Front Brake Line

1. Remove the front brake master cylinder cover, if not already removed.
2. Stand the motorcycle upright so the master cylinder is in a level position.

#### NOTE

*This instruction sheet covers motorcycle models that use either D.O.T. 4 or D.O.T. 5 Hydraulic Brake Fluid. Your model motorcycle's Owner's Manual, Service Manual, and Master Cylinder Cover will all indicate which type of brake fluid should be used for your motorcycle.*

*Do not mix grades of brake fluid as they are not compatible. Mixing different types of fluid may adversely affect braking ability and lead to brake failure which could result in death or serious injury.*

3. Add D.O.T. 4 Hydraulic Brake Fluid or D.O.T. 5 Hydraulic Brake Fluid (check your Owner's Manual, Service Manual, or Master Cylinder Cover for the correct type for your model motorcycle) **only** to the master cylinder reservoir until fluid level is 1/8 in. (3.2 mm) from the top. Do not reuse brake fluid. Use only brake fluid from a sealed container.

## WARNING

**Be sure the master cylinder relief port is not plugged. A plugged relief port can cause brake drag or lockup and loss of vehicle control, which could result in death or serious injury. (00317a)**

4. Verify proper operation of the master cylinder relief port. Actuate the brake lever. A slight spurt of fluid will break the fluid surface in the reservoir compartment if all internal components are working properly.

## WARNING

**After servicing brakes and before moving motorcycle, pump brakes to build brake system pressure. Insufficient pressure can adversely affect brake performance, which could result in death or serious injury. (00279a)**

5. Install one end of a length of plastic tubing over the caliper bleeder valve. Place the free end of the tubing into a suitable container.
6. Pump the front brake hand lever to build up hydraulic pressure.
7. **While holding the lever**, open the bleeder valve about 1/2 turn. Brake fluid will flow from the bleeder valve through the tubing. Close the bleeder valve as soon as a loss of pressure is detected. Allow the brake lever to return slowly to its released position.
8. Repeat Steps 3, 6, and 7 above until all air bubbles are purged.
9. Check the master cylinder and caliper banjo fittings and male/female connection under the lower triple clamp for any signs of leakage.
10. Tighten the bleeder valve to 80-100 **in-lbs** (9.0-11.3 Nm), then install the bleeder cap.
11. Add brake fluid to the master cylinder reservoir until the fluid level is about 1/8 in. (3.2 mm) from the top.

#### NOTE

*Before installing the master cylinder cover, verify that the cover gasket bellows is not expanded. If bellows is expanded, brake fluid will be ejected from the reservoir during cover installation, which could damage the vehicle finish.*

12. Note that the shape of the master cylinder cover has one end thinner than the other. Install the cover (with gasket compressed) on the master cylinder reservoir:
  - a. **for 2007 and earlier models**, so the **thinner** end is positioned above the brake line fitting.
  - b. **for 2008 and later models**, so the **thicker** end is positioned above the brake line fitting.
  - c. **ALL models**, install two Phillips-head screws to fasten the cover to the reservoir. Tighten the screws to 6-8 **in-lbs** (0.7-0.9 Nm).

## RETURN TO SERVICE

Verify that the Ignition/Light Key Switch is turned to the OFF position.

### Models WITH Maxi Fuse:

1. Refer to the Service Manual and follow the instructions given to re-install the Maxi® Fuse.

### Models WITHOUT Maxi Fuse:

#### WARNING

**Connect positive (+) battery cable first. If positive (+) cable should contact ground with negative (-) cable connected, the resulting sparks can cause a battery explosion, which could result in death or serious injury. (00068a)**

1. Apply a light coat of petroleum jelly or corrosion retardant material to the battery terminals. Refer to the Service Manual and follow the instructions given to re-attach the battery cables (positive cable first).
2. Install the seat according to the instructions in the Service Manual.

#### WARNING

**After repairing the brake system, test brakes at low speed. If brakes are not operating properly, testing at high speeds can cause loss of control, which could result in death or serious injury. (00289a)**

3. **ALL models:** Test ride the motorcycle. If the brake feels spongy, repeat the bleeding procedure.

## SERVICE PARTS

**Table 5. Service Parts: Upper Brake Line Kits**

Item	Description (Quantity)	Part Number
1	Brake Line, Diamondback, Upper (1)	Not Sold Separately
2	Washer, Sealing (Large I.D.) (2)	41733-88
3	P-Clamp, Small (2)	10059A
4	P-Clamp, Cushioned (1)	42364-07
5	Strap, Cable (3)	10065

**Table 6. Service Parts: Lower Brake Line Kits**

Item	Description (Quantity)	Part Number
1	Brake Line, Diamondback, Lower (1)	Not Sold Separately
2	Washer, Sealing (Small I.D.) (2)	41731-01
3	Strap, Cable (2)	10065
4	Screw (for Kit 45770-08 only)	3594
5	Washer, flat (for Kit 45770-08 only)	6703