

Adaptive LED Headlights - Model 8692 Adaptive

PRODUCT INFORMATION

Description	12V DOT/ECE LED High & Low Beam Adaptive Headlight w Black Inner Bezel - Pre-assembled 2 Light Kit
Height	143.00 mm / 5.63 in
Width	143.00 mm / 5.63 in
Depth	82.50 mm / 3.25 in
Shape	Round
Outer Lens Material	Polycarbonate
Outer Lens Color	Clear
Housing Material	Aluminum
Housing Color	Gray
Bezel Color	Black
Mounting Hardware Description	(x1) Stainless steel brackets and bolts
Mounting Type	Custom
Retrofits	HD Road Glide (2014 and older)
Minimum Operating Temperature	-40 °C / -40 °F
Maximum Operating Temperature	65 °C / 149 °F
Connector or Wiring	H4
Mating Connector	H4, AMP#172615-2
Product Weight	5.00 lbs / 2.27 kgs
Shipping Weight	7.08 lbs / 3.21 kgs



Print date: 2017-07-27

© 2017 J.W. Speaker Corporation • Germantown, WI U.S.A.
www.jwspeaker.com • speaker@jwspeaker.com • 262.251.6660

J.W. SPEAKER 
Engineered. Lighting. Solutions.

Adaptive LED Headlights - Model 8692 Adaptive

PRODUCT DIMENSIONS

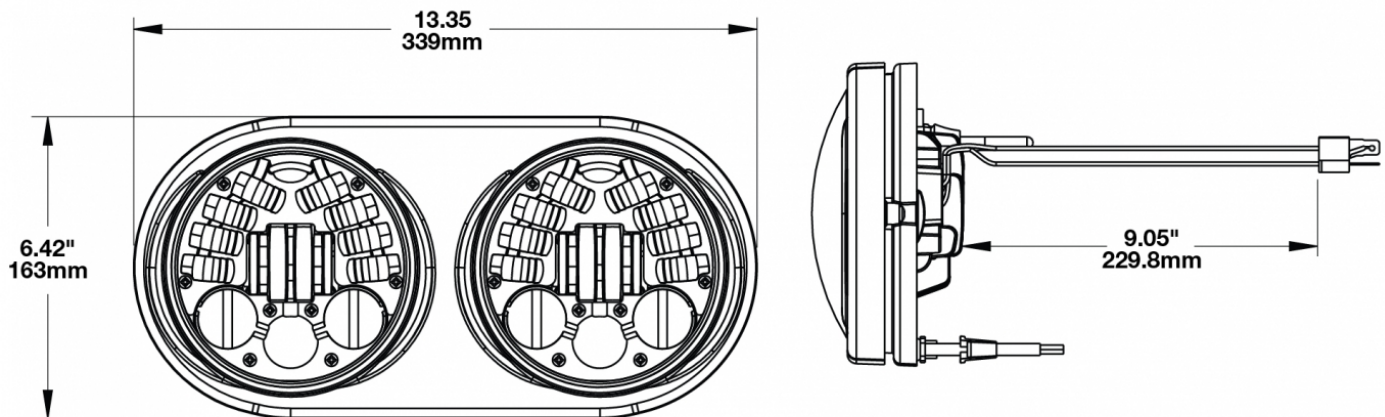

ELECTRICAL SPECIFICATIONS

Input Voltage	12V DC
Operating Voltage	9-16V DC
Transient Spike Protection	150V Peak @ 1 HZ-100 Pulses
Black Wire	Ground
White Wire	High Beam
Yellow Wire	Low Beam
Red Wire	Front Position
Current Draw	3.80A @ 12V DC (Low Beam) 6.40A @ 12V DC (High Beam) 0.42A @ 12V DC (Front Position) 8.40A @ 12V DC (Low Beam at Full Lean)

Print date: 2017-07-27

© 2017 J.W. Speaker Corporation • Germantown, WI U.S.A.
www.jwspeaker.com • speaker@jwspeaker.com • 262.251.6660

Adaptive LED Headlights - Model 8692 Adaptive

REGULATORY STANDARDS COMPLIANCE

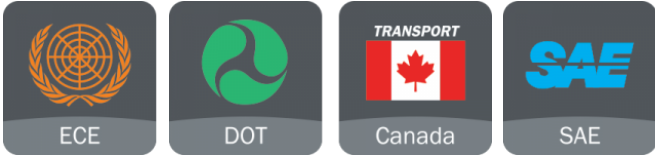

ECE Reg 113	ECE Reg 50
FMVSS 108 Table XX	IEC IP67
SAE J575	SAE J584

PHOTOMETRIC SPECIFICATIONS

Raw Lumen Output	7,020 (High Beam); 4,240 (Low Beam)
Effective Lumen Output	3,200 (High Beam); 2,040 (Low Beam)
Nominal LED Color Temperature	5000 K
Beam Pattern(s)	Forward Lighting - High Beam (DOT/ECE) Forward Lighting - Low Beam (DOT/ECE) Signalization - Front Position

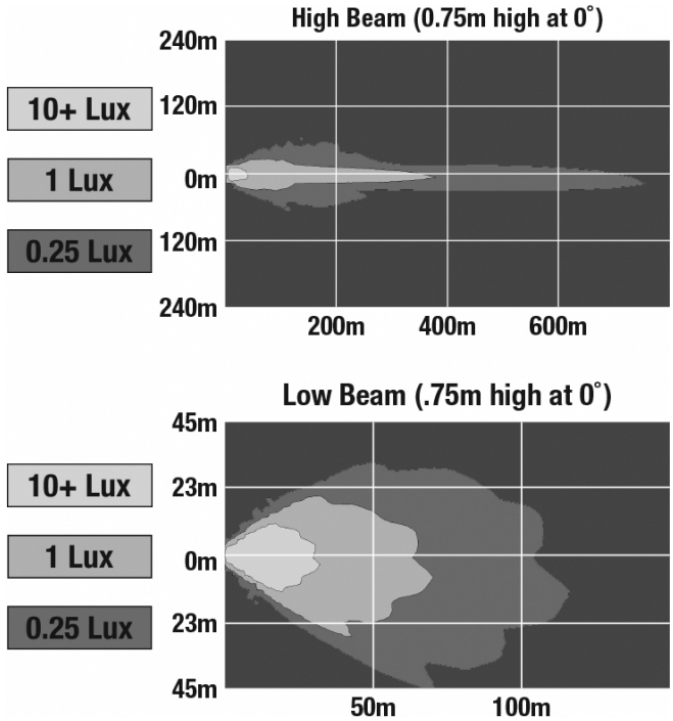

Print date: 2017-07-27

© 2017 J.W. Speaker Corporation • Germantown, WI U.S.A.
www.jwspeaker.com • speaker@jwspeaker.com • 262.251.6660



Adaptive LED Headlights - Model 8692 Adaptive

APPLICATIONS



INSTALLATION & APPLICATION INFORMATION

The headlights are designed to operate in a 2 lamp array. It requires 2 lamps to meet the legal requirements for both the high and low beams.

Headlight must be securely mounted and properly aimed such that the beam pattern cut off line complies with all applicable regulations. If you are not familiar with the legal requirements for aiming your headlights, please see a professional service provider. We recommend that headlights are aimed with a headlight aiming system for proper alignment.

ADDITIONAL INFORMATION

Note about Front Position: The front position light is a requirement outside the United States. **If your bike is operated in the United States you do NOT need to connect this wire (red)** unless your bike is equipped with a front position light.

RELATED PRODUCTS



Part Number

0553701

12V DOT/ECE LED High
& Low Beam Adaptive
Headlight w Chrome
Inner Bezel - Pre-
assembled 2 Light Kit

Print date: 2017-07-27

© 2017 J.W. Speaker Corporation • Germantown, WI U.S.A.
www.jwspeaker.com • speaker@jwspeaker.com • 262.251.6660

J.W. SPEAKER 
Engineered. Lighting. Solutions.