

Adaptive LED Headlights - Model 8691 Adaptive

PRODUCT INFORMATION

Description	12V DOT/ECE LED High & Low Beam Adaptive Headlight with Black Inner Bezel
Height	143.00 mm / 5.63 in
Width	143.00 mm / 5.63 in
Depth	82.50 mm / 3.25 in
Shape	Round
Outer Lens Material	Polycarbonate
Outer Lens Color	Clear
Housing Material	Aluminum
Housing Color	Black
Mounting Hardware Description	450
Retrofits	Pedestal 5 3/4" Round Headlights (PAR46)
Minimum Operating Temperature	-40 °C / -40 °F
Maximum Operating Temperature	65 °C / 149 °F
Product Weight	2.00 lbs / 0.91 kgs
Shipping Weight	2.92 lbs / 1.32 kgs



PRODUCT DIMENSIONS

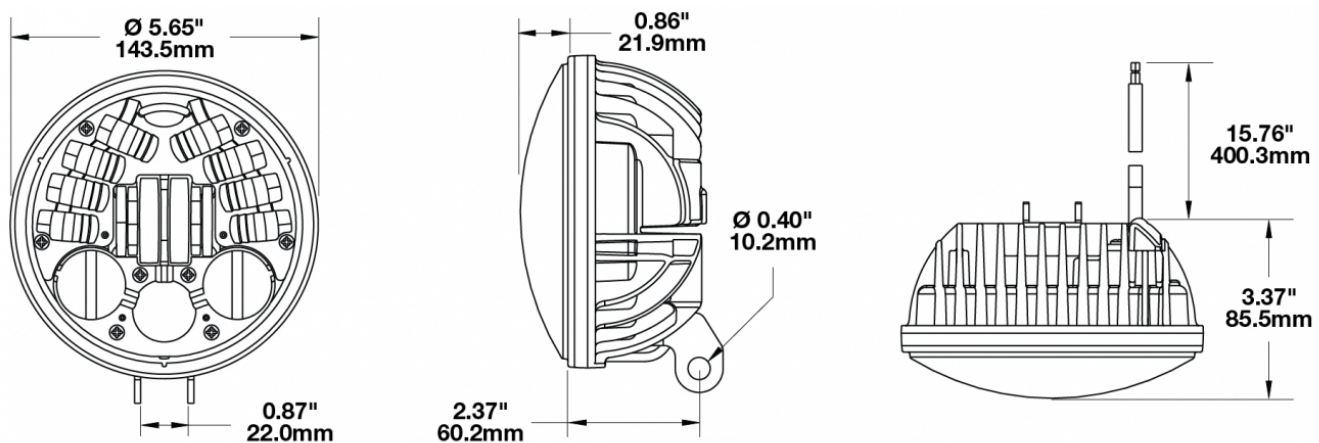

Print date: 2017-07-26

© 2017 J.W. Speaker Corporation • Germantown, WI U.S.A.
www.jwspeaker.com • speaker@jwspeaker.com • 262.251.6660

J.W. SPEAKER 
 Engineered. Lighting. Solutions.

Adaptive LED Headlights - Model 8691 Adaptive

ELECTRICAL SPECIFICATIONS

Input Voltage	12V DC
Operating Voltage	9-16V DC
Transient Spike Protection	150V Peak @ 1 HZ-100 Pul
Black Wire	Ground
White Wire	High Beam
Yellow Wire	Low Beam
Red Wire	Front Position
Current Draw	1.9A @ 12V DC (Low Beam) 3.2A @ 12V DC (High Beam) .21A @ 12V DC (Front Position) 4.2A @ 12V DC (Low Beam (full Lean))

REGULATORY STANDARDS COMPLIANCE



Buy America Standards
ECE Reg 50
FMVSS 108 Table XX

ECE Reg 113 Class D
Eco Friendly
IEC IP67

Print date: 2017-07-26

© 2017 J.W. Speaker Corporation • Germantown, WI U.S.A.
www.jwspeaker.com • speaker@jwspeaker.com • 262.251.6660

J.W. SPEAKER
Engineered. Lighting. Solutions.

Adaptive LED Headlights - Model 8691 Adaptive

PHOTOMETRIC SPECIFICATIONS

Raw Lumen Output	3,520 (High Beam); 2,120 (Low Beam)
Effective Lumen Output	1,600 (High Beam); 1020 (Low Beam)
Candela Output	60,000 (High Beam); 8,300 (Low Beam)
Nominal LED Color Temperature	5000 K
Beam Pattern(s)	Forward Lighting - High Beam (DOT/ECE) Forward Lighting - Low Beam (DOT/ECE) Signalization - Front Position

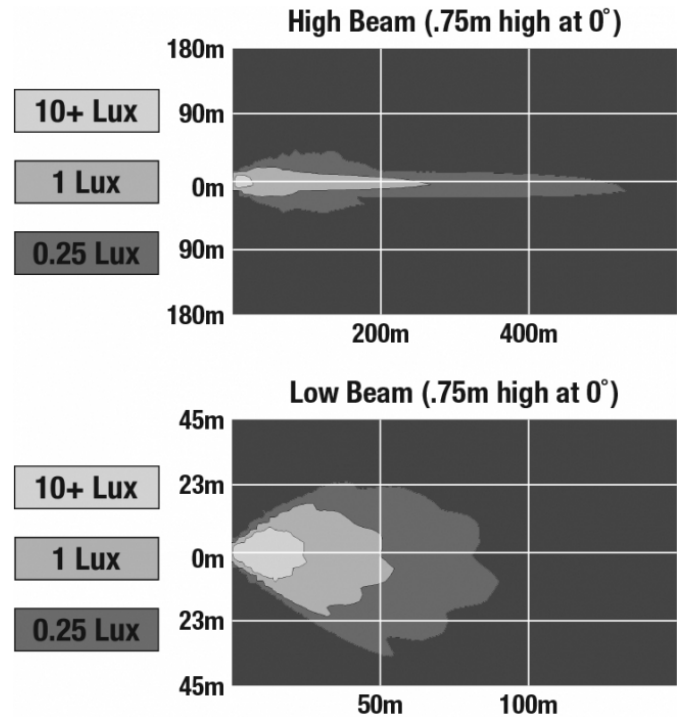

APPLICATIONS



INSTALLATION & APPLICATION INFORMATION

Headlight must be securely mounted and properly aimed such that the beam pattern cut off line complies with all applicable regulations. If you are not familiar with the legal requirements for aiming your headlights, please see a professional service provider. We recommend that headlights are aimed with a headlight aiming system for proper alignment.

Print date: 2017-07-26

© 2017 J.W. Speaker Corporation • Germantown, WI U.S.A.
www.jwspeaker.com • speaker@jwspeaker.com • 262.251.6660

Adaptive LED Headlights - Model 8691 Adaptive

ADDITIONAL INFORMATION

Note about Front Position: The front position light is a requirement outside the United States. **If your bike is operated in the United States you do NOT need to connect this wire (red)** unless your bike is equipped with a front position light.

RELATED PRODUCTS



Part Number

0552291

12V DOT/ECE LED High
& Low Beam Adaptive
Headlight with Chrome
Inner Bezel