

Adaptive LED Headlights - Model 8791 Adaptive

PRODUCT INFORMATION

Description	12V DOT/ECE LED High & Low Beam Adaptive Headlight with Black Inner Bezel
Height	180.00 mm / 7.09 in
Width	180.00 mm / 7.09 in
Depth	94.00 mm / 3.7 in
Shape	Round
Outer Lens Material	Polycarbonate
Outer Lens Color	Clear
Housing Material	Die-cast Aluminum
Housing Color	Black
Bezel Color	Black
Mounting Hardware Description	0.75" Pedestal
Retrofits	Pedestal 7" Round Headlights (PAR56)
Minimum Operating Temperature	-40 °C / -40 °F
Maximum Operating Temperature	65 °C / 149 °F
Connector or Wiring	Bare Leads
Shipping Weight	3.87 lbs / 1.76 kgs



Print date: 2017-07-27

© 2017 J.W. Speaker Corporation • Germantown, WI U.S.A.
 www.jwspeaker.com • speaker@jwspeaker.com • 262.251.6660

J.W. SPEAKER®
 Engineered. Lighting. Solutions.

Adaptive LED Headlights - Model 8791 Adaptive

PRODUCT DIMENSIONS

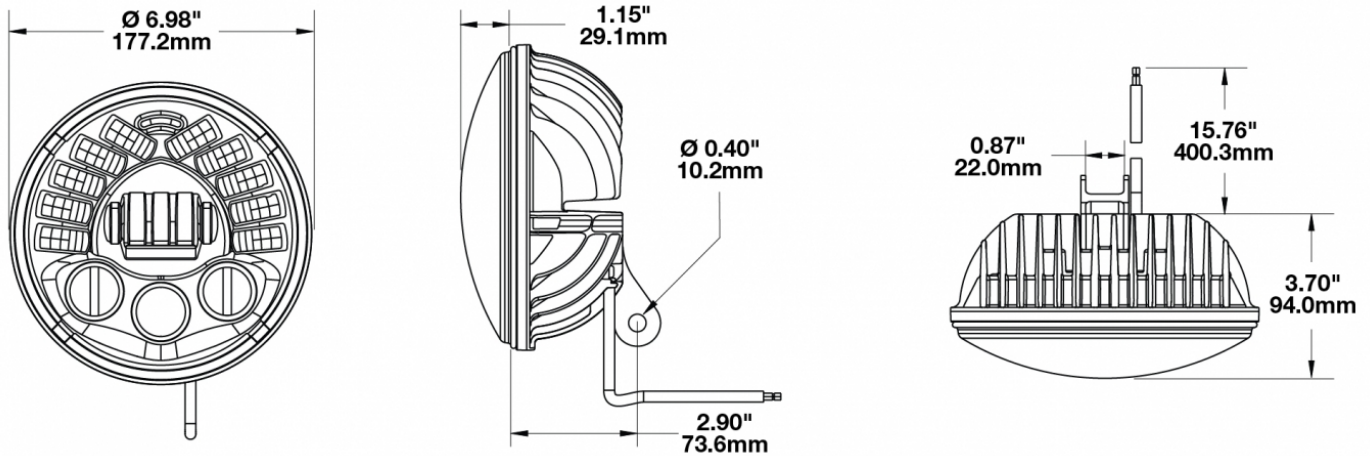

ELECTRICAL SPECIFICATIONS

Input Voltage	12V DC
Operating Voltage	9-16V DC
Black Wire	Ground
White Wire	High Beam
Yellow Wire	Low Beam
Red Wire	Front Position
Current Draw	2.90A @ 13.5V DC (High Beam)
	1.90A @ 13.5V DC (Low Beam)
	3.50A @ 13.5V DC (Low Beam + Lean)
	0.09A @ 13.5V DC (Front Position)

Print date: 2017-07-27

© 2017 J.W. Speaker Corporation • Germantown, WI U.S.A.
www.jwspeaker.com • speaker@jwspeaker.com • 262.251.6660

Adaptive LED Headlights - Model 8791 Adaptive

REGULATORY STANDARDS COMPLIANCE



Buy America Standards

Eco Friendly

Tested to ECE Reg. 10
(Radiated Emissions only)

PHOTOMETRIC SPECIFICATIONS

Raw Lumen Output	2,250 (High Beam); 2025 (Low Beam)
Effective Lumen Output	1,150 (High Beam); 850 (Low Beam)
Candela Output	48,000 (High Beam); 11,500 (Low Beam)
Nominal LED Color Temperature	5000 K
Beam Pattern(s)	Forward Lighting - High Beam (DOT/ECE) Forward Lighting - Low Beam (DOT/ECE)

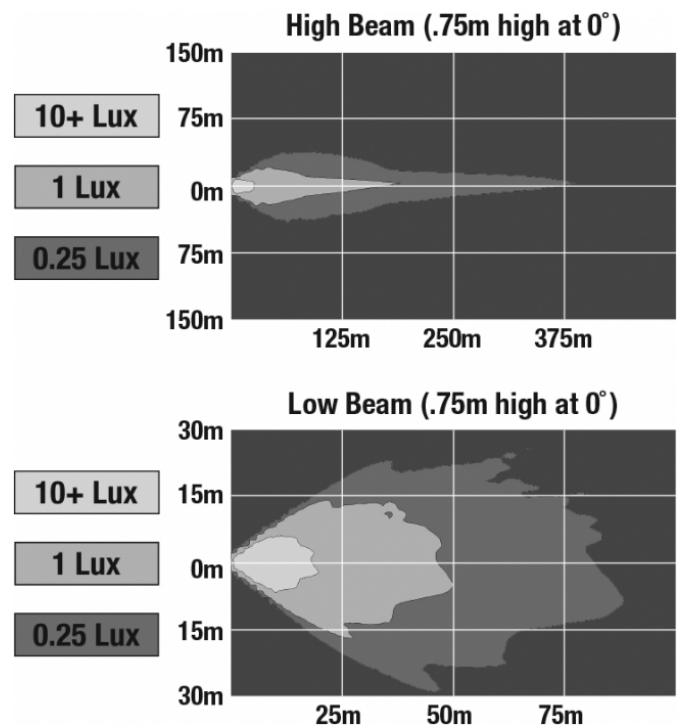

Print date: 2017-07-27

© 2017 J.W. Speaker Corporation • Germantown, WI U.S.A.
www.jwspeaker.com • speaker@jwspeaker.com • 262.251.6660

Adaptive LED Headlights - Model 8791 Adaptive

APPLICATIONS



INSTALLATION & APPLICATION INFORMATION

Headlight must be securely mounted and properly aimed such that the beam pattern cut off line complies with all applicable regulations. If you are not familiar with the legal requirements for aiming your headlights, please see a professional service provider. We recommend that headlights are aimed with a headlight aiming system for proper alignment.

ADDITIONAL INFORMATION

Note about Front Position: The front position light is a requirement outside the United States. **If your bike is operated in the United States you do NOT need to connect this wire (red)** unless your bike is equipped with a front position light.

RELATED PRODUCTS



Part Number

0552461

12V DOT/ECE LED High
& Low Beam Adaptive
Headlight with Chrome
Inner Bezel

Print date: 2017-07-27

© 2017 J.W. Speaker Corporation • Germantown, WI U.S.A.
www.jwspeaker.com • speaker@jwspeaker.com • 262.251.6660

J.W. SPEAKER 
Engineered. Lighting. Solutions.